



IP Office (R3.0)

5620SW + EU24 User's Guide

Contents

The 5620 IP Telephone	6
Overview of the 5620	6
Call Appearance Keys	8
Call Appearance/Function Key Icons	9
Basic Call Handling Features	10
Answer Incoming Calls	10
Make a Call	10
Clearing a Call	10
Headset Working	11
Speakerphone	11
Mute	12
Hold	12
Speed Dial	12
Redial	12
Transfer	13
Conference	13
Speed Dials	14
Overview of Speed Dials	14
Using Speed Dials	15
Dialing a Speed Dial	15
Adding a Speed Dial from the Call Log	15
Editing a Speed Dial	15
Deleting a Speed Dial	15
Adding a New Speed Dial	16
Using the Call Log	18
Overview of the Call Log	18
Using the Call Logs	19
To Access the Call Logs	19
To Display an Individual Log Entry	19
To Make a Call from an Individual Log entry	19
To Turn a Log Entry into a Speed Dial	20
To Delete an Individual Log Entry	20
To Delete All Entries from a Log	20
To Exit the Call Logs	20
Changing the 5620 Options	21
Telephone Options Overview	21
Application Options	22
Redial	22
Phone Screen on Answer	22
Phone Screen on Calling	22
Display Call Timers	23
Message Display Rate	23
Visual Alerting	23
Personal Ringing	24
View IP Settings	24
IP Address Settings	24
Quality of Service (QoS) Information	24
Phone Interface	24
Miscellaneous Information	24
Adjusting the Display Contrast	25
Logging off the 5620 IP Telephone	25
Backup/Restore Options	25
Changing Feature Key Labels	26
Language Selection	26

Contents (Cont.)

Function Keys	27
Overview of Function Keys	27
Function Key Programming	28
Shorthand Programming Mode	29
Longhand Programming	30
Function Key Features	30
Dial (#)	30
Group (#)	31
User (#)	31
Absnt - Set Absent Text	31
Acct - Account Code Entry (!)	31
AD - Abbreviated Dial (!)	32
Admin - Self-Administer (!)	32
Apear - Appearance	32
AutCB - Automatic Callback (!)	32
Busy - Busy	33
BusyH - Busy On Held	33
CFrwd - Call Forwarding All (!)	33
ClrCW - Clear CW	34
CnfRV - Conference Meet Me	34
Conf+ - Conference Add	34
CPark - Call Park (!)	34
CPkUp - Call Pickup (!)	35
CWOff - Call Waiting Off	35
CWOOn - Call Waiting On	35
CWSus - Call Waiting Suspend	35
DCW - Dial CW	36
Dir - Directory (!)	36
Dirct - Dial Direct	36
DNDOOn - Do Not Disturb On	36
DNDOOff - Do Not Disturb Off	37
DNDX+ - Do Not Disturb Exception Add	37
DNDX- - Do Not Disturb Exception Delete	37
DPkUp - Directed Call Pickup (!)	37
Drop - Drop (!)	38
DTone - Secondary Dial Tone	38
Emrgy - Dial Emergency	38
Flash - Flash Hook (#)	38
FolTo - Follow Me To	38
FwBNo - Forward On Busy Number	39
FwBOn - Forward On Busy On	39
FwBOOff - Forward On Busy Off	39
FwdH+ - Forward Hunt Group Calls On	40
FwdH- - Forward Hunt Group Calls Off	40
FwdNo - Forward Number	40
FwdOf - Cancel All Forwarding	40
FwNOOn - Forward On No Answer On	41
FwNOOff - Forward On No Answer Off	41
FwUOn - Forward Unconditional On	41
FwUOff - Forward Unconditional Off	41
GrpPg - Group Paging (!)	41
HdSet - Headset Toggle (!)	42
Here- - Follow Me Here Cancel	42
Here+ - Follow Me Here	42

Contents (Cont.)

HfAns - Internal Auto-Answer (!)	42
HGEa - Hunt Group Enable	43
HGDis - Hunt Group Disable	43
HGNS+ - Set Hunt Group Night Service (!)	43
HGNS- - Clear Hunt Group Night Service	43
HGOS+ - Set Hunt Group Out of Service	44
HGOS- - Clear Hunt Group Out of Service	44
Hold - Hold Call	44
HoldCW - Hold Call Waiting	44
IAuto - Automatic Intercom	45
ICSeq - Set Inside Call Sequence	45
IDial - Dial Intercom	45
Inclu - Dial Inclusion	45
Intru - Call Intrude	45
Listn - Call Listen	46
Login - Extn Login	46
Logof - Extn Logout	46
Music - Hold Music	46
NATim - Set No Answer Time	47
OCSeq - Set Outside Call Sequence	47
Page - Page	47
Park - Park (#)	47
Park - Call Park to Other Extension (!)	48
PCall - Priority Call	48
PhyEx - Dial Physical Extension by Number	48
PickA - Call Pickup Any	49
PickG - Call Pickup Group	49
PickM - Call Pickup Members	49
Prog - Abbreviated Dial Program (!)	49
Quota - Clear Quota	50
Queue - Call Queue	50
RBak+ - Ringback When Free	50
RBak - Cancel Ringback When Free	50
RBSeq - Set Ringback Sequence	51
Recor - Call Record	51
Relay - Relay Pulse	51
Rely+ - Relay On	51
Rely- - Relay Off	51
Resum - Resume Call	52
Rtriv - Retrieve Call	52
Ride - Ride Call	52
RngOf - Ringer Off (!)	52
SAC - Send All Calls (!)	53
Spres - AD Suppress (!)	53
Steal - Call Steal	53
SusCW - Suspend CW	53
Suspe - Suspend Call	54
Timer - Timer (!)	54
TmDay - Time of Day (!)	54
Toggl - Toggle Calls	54
VMRB- - Voicemail Ringback Off	54
VMRB+ - Voicemail Ringback On	55
VMCol - Voicemail Collect	55
VMOff - Voicemail Off	55
VMOOn - Voicemail On	55
WUTim - Set Wrap Up Time	55

Contents (Cont.)

System Features	56
Introduction	56
Making Calls	56
Answering Calls	56
Call Waiting.....	57
Call Forwarding.....	57
Diverting Calls.....	57
Do Not Disturb	57
Voicemail	58
Default Feature Codes.....	58
Web Browsing	59
Overview of Web Browsing	59
Accessing External WAP Websites	59
Web Navigation Controls	60
Entering Data.....	61
Management and Troubleshooting	62
Overview.....	62
Testing your phone	62
Testing the Telephone's Lights and Display	62
Troubleshooting Chart	62
Resetting the IP Telephone	64
Resetting Your Phone.....	64
Power Cycling Your Phone.....	64
EU24 Expansion Module	65
EU24 Overview	65
Connection.....	65
Using the EU24 Expansion Module	66
Viewing the Alternate Display.....	66
Selecting a Call Appearance/Feature Button	66
Understanding Call Appearance/Feature Button Status Icons.....	66
Index	67

The 5620 IP Telephone





Overview of the 5620

This guide covers the use of the Avaya 5620 telephone, running in Key and Lamp mode, on Avaya IP Office telephone systems operating with Level 3.0 software. The diagram below shows the main 5620 telephone features.



1. **Display, Call Appearance and Feature buttons:** The Call Appearance Keys allow the user to handle multiple calls with the display showing call information, e.g. the name/phone number, etc. There are four pages in the display; giving (at default) three call appearance lines and up to 21 system features that can be allocated to the function keys. See Call Appearance Keys on page 8 and Function Keys on page 27.
The information displayed varies according to the active feature.
2. **Message waiting lamp:**
Lit continuously when the user has voicemail messages waiting. Can also be set to flash when the phone is ringing.
3. **◀ ▶ Page Right/Left:**
Shifts from one page to another in the same application when the display presents the paging indicator (↔). These buttons have no effect when the paging indicator is not displayed.
4. **Options:**
Displays the Options main screen, from which display and application settings can be updated.

5. Call Handling Buttons: See Basic Call Handling on page 10.

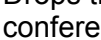
-  **Hold:**
Red button used to place a call on hold
-  **Transfer:**
Transfers a call to another phone
-  **Conference:**
Sets up conference calls with more than one other person.
-  **Drop:**
Drops the current call or, if on a conference call, drops you from the conference.
-  **Redial:**
Redials the last number dialed or displays the last 6 numbers dialed from the phone, depending on configuration via the Options menu.

6. Numeric (Dialing) Pad:

Standard 12 button pad for dialing phone numbers.

7.   Volume Controls:

Adjusts the handset, speaker, headset, or ringer volume, depending on which item is in use. As you increase or decrease the volume, the top display area provides either a speaker, headset, handset, or ringer icon to indicate for which item you are adjusting volume, followed by a visual “volume meter” showing the volume level. These buttons also control the volume of the key click sounds made when you press fixed buttons on the phone, such as the dial pad or softkeys.

8.  Mute and LED Indicator:

Turns off the active Speaker, handset, or headset microphone to prevent the other person from hearing you. The associated LED lights steadily when the handset or headset is muted.

9.  Headset and LED Indicator:

With a headset connected, changes audio control from the handset or speaker to the headset. The associated LED lights steadily when the headset is active. The headset jack socket is located on the base of the telephone underneath the front edge.

10.  Speaker and LED Indicator:

Access the speakerphone. The light associated with this button turns on when the speakerphone is active.

11.  Phone/Exit:

Displays the phone application main screen or, if applicable, exits the current IP Office based feature, such as Speed Dial or Call Log, and normalizes the display.

12.  Softkeys:

Used to navigate to or initiate certain features, such as Speed Dial or Call Log, as well as control certain actions within the features. These keys correspond to the text prompts in the display screen immediately above them.

Call Appearance Keys

There are four pages of Call Appearance and Function Keys. You can step through these with the ◀ ▶ keys. At default, first page of the main call screen contains three keys set as 'call appearance' keys. These keys show that the 5620 is a multi-line phone and are indicated as **a=**, **b=** and **c=**. The remaining 21 Function Keys can have system features allocated to them, by your System Administrator, that are specific to your requirements (see page 27).

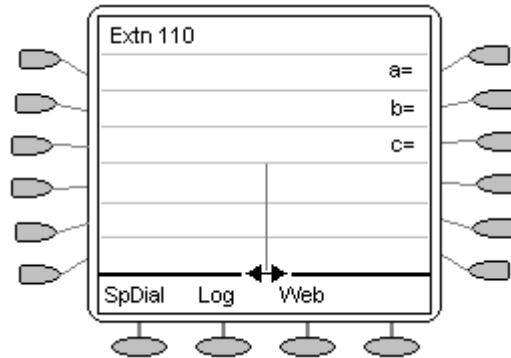

Your System Administrator can change a call appearance key with:

- **A Bridged Appearance**
A bridged appearance key matches the status and operation of the Call Appearance Key on a pre-defined colleague's telephone. Hence, you can pick-up, make and receive calls on behalf of your colleague.
- **A Line Appearance**
An IP Office exchange line (but not IP lines) can be allocated to you such that the status of that line is displayed and you can use the line appearance key to make and receive calls.
- **Call Coverage Appearance**
A call coverage appearance key alerts you when a pre-defined colleague is receiving a call. The covered user does not need to be using call appearance keys. Hence, you can pick-up calls on behalf of your colleague.
- **A System Feature**
System Features, such as *Abbreviated Dial* (that automatically dials a frequently used number) can be set against key and/or dial pad digits. See Function Keys on page 27.

All of the above can only be allocated to you by your System Administrator.

For details of Bridged, Line and Call Coverage Appearance Keys set-up and their operation, refer the *IP Office Key and Lamp Operation* manual.

CAUTIONS:

1. Having **more than two** Call Appearance keys is very useful. When holding a call you can answer/make another call and then switch between calls or transfer or conference. If you are set to receive *call waiting* indication, the waiting call is shown against the next call appearance key.
2. Although the System Administrator can replace the Call Appearance Keys with:
 - A Bridged Appearance
 - A Line Appearance
 - Call Coverage Appearance
 - System Features

This would severely restrict the use of features such as conference and transfer.

It is for these reasons that it is **strongly recommended** that all Call Appearance keys **remain at their default settings**.













System Features

System Features **can only be** set against soft Function Keys by your System Administrator. However, your System Administrator may allocate you two 'self administrator' features that will enable you to add System Features to your soft Function Keys. Refer to *Function Key Features* on page 30 for details of the System Feature that **can only be allocated to you** by your System Administrator.

In addition, there are a number of System Features that you **can always access yourself** by the use of short codes. Refer to *System Features* on page 56 for details of System Features that **you can always access** yourself by dialing short codes, e.g. *17 to listen to your VoiceMail messages.

Call Appearance/Function Key Icons

The icons displayed against the Call Appearance/Feature Keys allow you to determine the status (for example, on Hold) of each call. Icons also indicate whether a feature has been activated for a particular button.

- **Incoming Call:** 
A  symbol next to a call appearance key indicates an incoming call. Pressing the adjacent   key answers the call and puts any other current call on hold.
- **Connected:** 
A  symbol next to a call appearance key indicates that it is the currently connected call. The caller's telephone number (if available) is also shown. Pressing the adjacent   key puts the call on hold. An **H** is also shown on the display.
- **On Hold:** 
A  symbol next to a call appearance key indicate a call on hold. Pressing the adjacent   key takes the call off hold and puts any other current call on hold.
- **Function Active:** ◀ or ▶
The button to the left or right of the function key is active.

Basic Call Handling Features

Answer Incoming Calls

When a call arrives at your 5620 telephone, you will hear a ringing tone and a blinking bell icon () icon appears against the associated call appearance key.

To answer an incoming call:





Do one of the following:

- If you are not active on another call, answer the call using your handset, headset, or speakerphone (see Speakerphone on page 11).
- If you are active on a call already, place the active call on hold (see Hold on page 12), and then answer the incoming call by selecting the call appearance key.
- If the call appearance for the ringing call is not displayed on the current screen page, use  **Exit** to return to the first page of the Home screen. When you locate the call appearance for the ringing call, press the corresponding call appearance button.

Make a Call



You can make calls from the 5620 telephone using a variety of methods as follows:

To manually make a call:

1. Dial the required number on the key pad (remember to include the required access code (for example, 9) for an outside line) and listen to the progress of the call.
2. Adjust speakerphone volume as necessary.
 - To change the volume use the  and  buttons. The display shows the volume level. (There are eight volume levels.)
3. If the call is not answered, you can clear the call by pressing  **Speaker** or  **Drop**
or
4. When the call is answered, either speak or pick up the handset and speak to the called party.

To automatically make a call:

Do any of the following:

- Press  **Redial**. Select from up to the last three dialed numbers and press the key  next to next to your choice.
or
- Access the Call Log and initiate a call to a specific entry.
See To Access the Call Logs on page 19.
or
- Access the Speed Dial List in your personal directory and initiate a call to a specific entry. See Using Speed Dials on page 15.
- When the call is answered, either speak or pick up the handset and speak to the called party.

Clearing a Call

To clear an established call either:

1. Replace the handset
or
2. Press  **Drop**. You will hear dial tone, unless you are in 'call centre mode' of working when you will then hear silence.

Headset Working

When a headset is to be used on your 5620, it must be plugged in to the headset socket on the side of your 5620 telephone. To activate the headset and switch off the handset, press  **Headset**. The lamp beside the button is illuminated when headset working is activated.

To answer an incoming call:

1. Press the call appearance key next to the flashing bell icon (

To clear a headset call:



1. Press  **Drop**.

To manually make a call:

1. Dial the number (remember to include the required access code (for example, **9**) for an outside line) and listen to the progress of the call.

To automatically make a call:





Do any of the following:

- Press  **Redial**. Select from up to the last three dialed numbers and press the key  next to your choice.
or
- Access the Call Log and initiate a call to a specific entry.
See Using the Call Log on page 18.
or
- Access the Speed Dial List in your personal directory and initiate a call to a specific entry. See Using Speed Dials on page 15.
- When the call is answered, speak to the called party.

Speakerphone

The two-way built-in speakerphone allows you to make and answer calls without lifting the handset. Keep in mind that two-way speakerphones may not operate satisfactorily in every environment (such as in very noisy locations).



To make or answer a call without lifting the handset, or to use the speakerphone with any feature:

1. Press  **Speaker**. The LED beside the  button illuminates.
2. Make or answer the call, or access the selected feature.
3. Adjust the speakerphone volume if necessary.
 - To change the volume, use the  and  buttons. The display bar at the top of the display screen shows the volume level.
(There are eight volume levels.)

To change from the speakerphone to handset (or headset if fitted)

1. Pick up the handset (or press  **Headset**) and talk.

Changing from handset to speakerphone:

1. Press  **Speaker**. The LED beside the  button illuminates.
2. Hang up the handset.



Ending a speakerphone call:

1. Press  **Speaker** again. The LED beside the  button goes out.

Mute

During an active call, the Mute feature prevents the party with whom you are speaking from hearing you. This feature is most commonly used in conjunction with the Speakerphone, but can be used to hold an off-line conversation at any time during a call.

Preventing the other person on the line from hearing you:

1. Press  **Mute**.
 - The other party cannot hear you. The indicator next to the **Mute** button lights when **Mute** is active.
2. To reinstate two-way conversation, press  **Mute** again.

Hold



The Hold feature puts a call on hold until you retrieve it.

Placing a call on hold:

1. Press the  **Hold** or the Call Appearance key for the call.
 - The  Hold icon is displayed.

Retrieving the held call:

1. Press the call appearance key with the  Hold icon is displayed.
 - The call is now active.



Note: After a pre-set time (defined by your System Administrator), you are reminded that you have a call on hold by the  hold icon changing for a few moments to  and the phone ringing.

Also see Transfer on page 13.

Speed Dial

The Speed Dial feature allows you to have the 5620 telephone automatically dial calls to telephone numbers stored in your personal directory. See Speed Dials on page 14.

To make a call to a personal directory entry using the Speed Dial feature:

1. Press the  **SpDial** softkey. The Speed Dial screen is displayed.
2. Press the button next to the entry you want to call.
3. If the entry you want is not displayed, use  and  to cycle through the entries **or** key the first letter of the required name to jump to the page with a matching entry.
4. The 5620 telephone dials the number for you.

Redial

The Redial (or Last Number Dialed) feature automatically redials a previously dialed extension or outside number (up to 24 digits). Your 5620 will store the up to three of the last numbers dialed.

Note: If you have dialed the same number twice in succession, it will only have one appearance in the redial list.







To redial previously dialed number:

1. Press  **Redial** and press the call appearance key next to the required number.

Transfer

The Transfer feature allows you to transfer a call from your telephone to another extension or outside number.

To transfer the current call to another extension



1. With a call in progress, press  **Transfer** or  **Hold**.
2. When you hear dial tone, dial the number to which the call is to be transferred.
3. Do one of the following:
 - To transfer the call without announcing it, press  **Transfer** again and hang up. The transfer is complete.
 - To announce the call before transferring it, wait for the called party to answer. If the called party is willing to accept the call, press  **Transfer** again to complete the transfer.
If the called party does not wish to accept the call, press  **Drop**. You can return to the held call by pressing its call appearance button.
 - If the line is busy or if there is no answer, press  **Drop**.
You can return to the held call by pressing its call appearance button.

Conference



The Conference feature allows you to conference other parties (including yourself) into a call.

- Notes:**
1. The number of parties allowed in a conference is controlled by your telephone system.
 2. Two Call Appearance keys are required for the conference feature.

To add another party to a call:

1. Press  **Conference**.
2. Dial the number of the person you want to add to the call.
3. Wait for an answer.
4. To add the person to the call, press  **Conference** again.
 - If the called party does not answer or does not want to join the conference, press  **Drop**.
You can return to the held call by pressing its call appearance button.
5. Repeat steps 1 through 4 for additional conference connections.

To add a held call to an active call:

1. Press  **Conference**.
2. Press the call appearance button corresponding to the held call.
3. Press again  **Conference**.

To leave a conference call:

To leave a conference, press  **Drop**.

Speed Dials

Overview of Speed Dials

The 5620 can store up to 108 personal speed dials, accessed by selecting **SpDial** on the display.

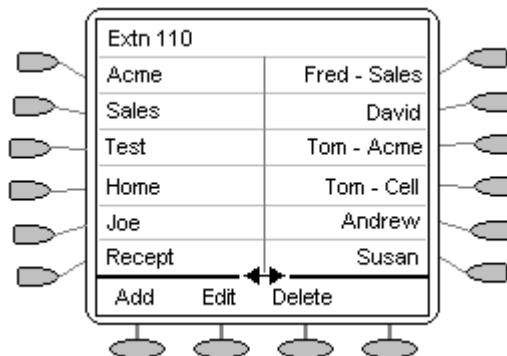

- The speed dials are sorted alphabetically.
- Pressing the **Left** or **Right** key adjacent to a name, dials the speed dial number stored with that name.
- The **Left/Right** symbol indicates that there are more pages.
You can move between pages using the **Page Left** and **Page Right** keys.

Pressing **Add** allows you to add a new speed dial. See Adding a New Speed Dial on page 16.







You can also press **Edit** to display an existing speed dial and edit its current settings. Editing a Speed Dial on page 15.

Note: Speed dials can be used for any numbers that can be manually dialed from the extension. Where, for external calls, a dialing prefix is required then that prefix must be part of the speed dial number.

Using Speed Dials

Dialing a Speed Dial







You can use the speed dial directory to make a call with the handset on hook or off hook.

1. Press  **SpDial** to display the speed dial directory.
 2. The   symbol is shown if there is more than one page of speed dials. You can move between pages using the  **Page Left** and  **Page Right** keys.
 3. When the speed dial required is shown on the screen, press the  or  key adjacent to the speed dial name.
 4. Continue as per a normal call.
-





Adding a Speed Dial from the Call Log

You can create a new speed dial from a call log entry. See To Turn a Log Entry into a Speed Dial on page 20. This process will start the normal speed entry screen but pre-filled with the name and number from the call log entry.

Editing a Speed Dial

1. Press  **SpDial**
 2. Press  **Edit**.
 3. Select the speed dial entry you want to edit.
Press  and  to display different pages of speed dials.
 4. When the required entry is displayed, press the adjacent  or  key.
 5. Edit the speed dial using the same methods as for adding a new speed dial. See Adding a New Speed Dial on page 16.
 6. Press  **Save** to return to the speed dial list
-

Deleting a Speed Dial

1. Press  **SpDial**
2. Press  **Delete**.
3. Select the speed dial entry you want to delete.
Press  and  to display different pages of speed dials.
4. When the required entry is displayed,  **Delete** again or  **Cancel** to exit without deleting.
5. Select another entry to delete or press  **Exit** to return to the speed dial list.

Adding a New Speed Dial

1. Press **SpDial** followed by **Add**. If **Add** does not appear, then the speed dial list is full. Hence, you must first delete an existing entry before adding any new entry. See Deleting a Speed Dial on page 15.

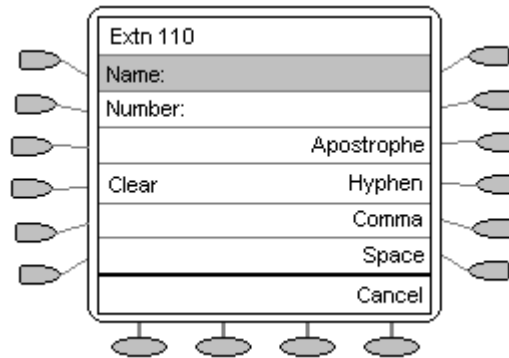

2. Begin entering text using the telephone keypad. Each key is marked with the letters it provides. You may have to press the key more than once depending on the character you require.

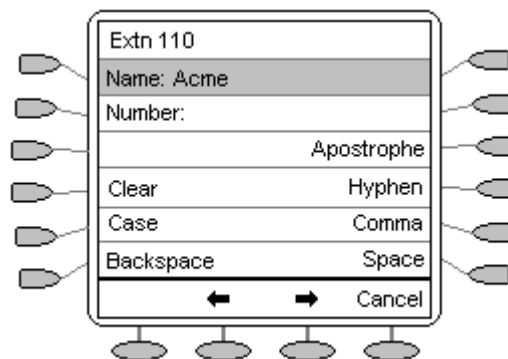

- For example, the **2** key is also marked as **A**, **B** and **C**. To enter a **C** press the key until a C is displayed.
 - To enter the next character *from the same key*, e.g. **a**, press **→** to move the cursor right and then enter the character or simply press another key.
 - If you make a mistake, use **←** or **→** to move the cursor to the right of the incorrect character and then use **Backspace** to delete it.
4. As you enter the **Name** characters you can use a number of other controls.
 - **Case** - Change the case of the current character between upper and lower case.
 - **→** - Moves the cursor right one character.
 - **←** - Moves the cursor left one character
 - **Clear** - Delete the whole name.
 - **Backspace** - Delete the character to the left of the cursor.
 - **Apostrophe** – Inserts an Apostrophe between characters.
 - **Hyphen** – Inserts a Hyphen (-) between characters.
 - **Comma** – Inserts a Comma (,) between characters.
 - **Space** – Inserts a space between characters.
 - **Cancel** - Return back to the speed dial directory without making any changes.
 5. When the **Name** has been entered, press **Number**.

6. The **Number** menu is displayed. Enter the required number, including any external line access digit (9 say):

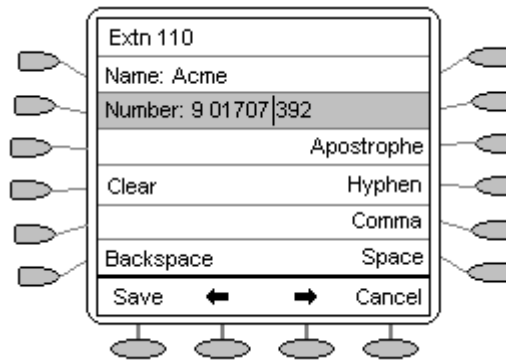

- If you make a mistake, use or to move the cursor to the right of the incorrect character and then use **Backspace** to delete it.
7. As you enter **Number** characters you can use other controls.
- Note:** The controls on this screen are context sensitive, i.e. they only appear when applicable. For example **Save** only appears when both a name and number have been entered.
- - Moves the cursor right one character.
 - - Moves the cursor left one character.
 - **Clear** - Delete the whole number.
 - **Backspace** - Delete the character to the left of the cursor.
 - **Apostrophe** – Inserts an Apostrophe between characters.
 - **Hyphen** – Inserts a Hyphen (-) between characters.
 - **Comma** – Inserts a Comma (,) between characters.
 - **Space** – Inserts a space between characters.
 - **Save** - Save the speed dial changes.
 - **Cancel** - Return back to the speed dial directory without making any changes.
8. When the **Number** has been entered, press **Save**.

Using the Call Log

Overview of the Call Log

The 5620 maintains a call log, accessed by selecting **Log** on the display.

The call logs keeps logs of missed calls, outgoing calls made and incoming calls answered. Each of these logs includes the 30 most recent calls in its category. The details shown are:

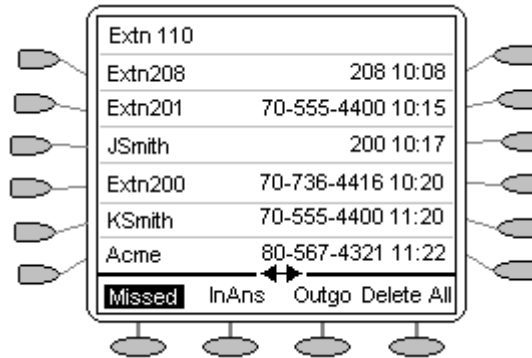

- The name of the called or calling party if available.
- The number of the called or calling party.
- The time of the call.
- The date of the call if prior to the current day.
- The **↔** symbol indicates that the log contain more pages of entries. You can more between pages using the **Page Left** and **Page Right** keys.

Note: Only outgoing calls made using the dial pad or a **SpDial** entry are logged.

Pressing the **Left** or **Right** key adjacent to a log entry displays full details of that log entry: Each individual log entry includes:

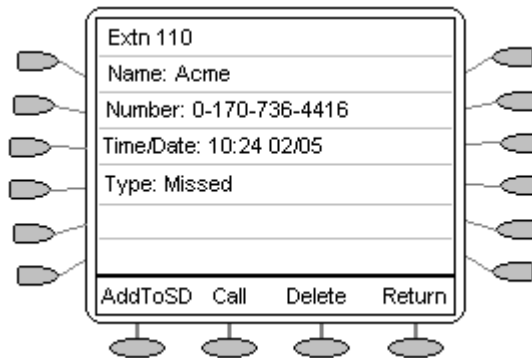

- The number of the called or calling party if available.
- The number of the called or calling party.
- The time of the call.
- The date of the call.
- The duration of the call for outgoing and answered calls (not shown above for missed calls)

Using the Call Logs

Apart from using the call logs for information, you can turn a call log entry into a speed dial for future calls. You can also delete individual log entries or the all entries in a particular log. The following paragraphs detail how to use the Logs.

Note: Call log entries are lost whenever 5620 telephone are disconnected from the IP Office.

To Access the Call Logs

1. Press **Log**.
2. The call log always opens in the **Missed** calls log.

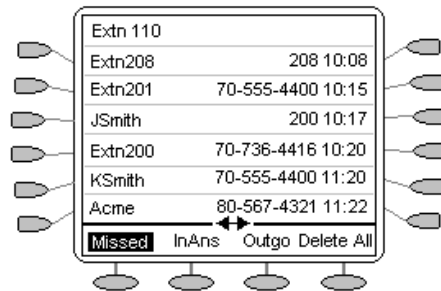

- **Missed:** The log of missed calls, i.e. those calls that rang your extension but were not answered. This includes calls that were diverted to voicemail or another number after ringing your extension.
3. To select the log required type press either:
 - **InAns:** The log of incoming calls that were answered. This includes both internal and external calls.
 - **Outgo:** The log of calls made. This includes both internal and external calls.
 4. If the selected log contains more than one page of entries, the **↔** is shown. Use the **Page Left** and **Page Right** keys to move between pages.

To Display an Individual Log Entry

1. Locate the log entry in which you are interested from **Missed**, **InAns** or **Outgo**.
2. Press the **□** or **▢** key adjacent to the entry.
3. The log entry details are shown.

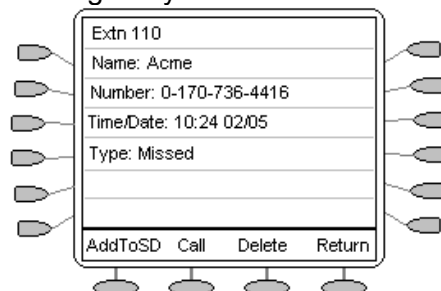









4. Using **Return** key to return to the call log.







To Make a Call from an Individual Log entry

1. Locate the log entry in which you are interested from **Missed**, **InAns** or **Outgo**.
2. Press the **□** or **▢** key adjacent to the entry.
3. The log entry details are shown.
4. Press **Call** make the call.
If the number shown is external but doesn't include the external dialing prefix used by your telephone system, go off-hook, dial the prefix and then press **Call**.







To Turn a Log Entry into a Speed Dial

1. Locate the log entry in which you are interested from  **Missed**,  **InAns** or .
2. Press the  or  key adjacent to it.
3. Press  **Add to SD**.
4. The screens for editing and adding speed dials will appear, pre-filled with the information from the log entry. Edit the details if required (see Editing a Speed Dial on page 15).
5. Press  **Save** or .
6. You will be returned to the speed dials selection menu.

To Delete an Individual Log Entry

1. Locate the log entry in which you are interested from  **Missed**,  **InAns** or .
2. Press the  or  key adjacent to it.
3. Press  **Delete** twice. **Or:**
Press  **Cancel** to return to the call log without deleting the log entry.
4. You will be returned to the call log.

To Delete All Entries from a Log

1. Press  **Log**.
2. Press  **Missed**,  **InAns** or  **Outgo** to select the log.
3. Press  **DeleteAll**.
4. Select  **Delete** to delete the log entries. Press  **Cancel** to return to the call log without deleting the log entries.

To Exit the Call Logs

1. Press  **Exit**.

Changing the 5620 Options

Telephone Options Overview

The  **Options** button will allow viewing and configuring of certain phone settings. These options are different from the function keys that require configuration by the system administrator.

The phone settings available include:

Application Option:

- Displaying the Phone screen when making a call and/or answering a call.
- Determining how you want the Redial feature to work (redial the last number called or select from a list of the last three calls).
- Displaying the Call Timer.
- Changing the rate at which messages display.
- Allowing the Voice message light to flash when the telephone rings.

Personal Ringing

- Select from eight personal ringing tones.

IP Options:

- View the IP Addresses data
- View the QoS data
- View the interface data
- View miscellaneous data on the 5620 telephone.

Contrast Control

- Allows you to change the contrast of your 5620 telephone' display.

Log Off

- Allows you to log your telephone off to prevent unauthorized use during an absence, or for privacy purposes.

Backup/Restore

- Provides protection of your personal options, preference setting, speed dial data, etc in the case of system failure.

This option must only be used by the System Administrator.

Feature Button Labeling

- Enables you to change a feature key label, e.g. SAC to DoNotDisturb.

PC Ethernet interface

- Displays and enables the PC Ethernet setting to be changed.
- This option must only be used by the System Administrator.**

Select display language





- Enables you to select which of eight languages is used to on your 5620 display. Does not effect the language selected on the IP Office.

Application Options

Redial

 **Redial** can be configured to dial the last number dialed or list the last three numbers dialed for you to choose from. The default is the last number dialed.

To change **Redial**:

1. Press  **Options**,  **Applications Options** and then select the  **Redial** feature button. It will toggle between **Last Number** and **Last 3 Numbers**.
2. Select  **Save**.
(To restore the previous setting without changing it, press  **Cancel**.)

After saving or canceling, the first Options main screen is displayed.





Phone Screen on Answer

This action controls the phone screen display when the phone is answered.

When the **Phone Screen on Answer?** option is set to **Yes** (the default setting), the phone screen appears in the display area when you answer a call, regardless of the screen you were working with at that time. You will lose any unsaved work in progress on that screen (for example, labeling a Speed Dial button).

When the **Phone Screen on Answer?** option is set to **No** answering an incoming call has no impact on the application screen displayed, although the top display line will provide an appropriate message.

To change **Phone Screen on Answer**:

1. Press  **Options**,  **Applications Options** and then select the **Phone Screen on Answer** feature button. It will toggle between **Yes** and **No**.
2. Select  **Save**.
(To restore the previous setting without changing it, press  **Cancel**.)

After saving or canceling, the first Options main screen is displayed.





Phone Screen on Calling

This action controls the phone screen display when you make a call.

When the **Phone Screen on Calling?** option is set to **Yes** (the default setting), the phone screen appears in the display area when you make a call, regardless of the screen you were working with at that time. You will lose any unsaved work in progress on that screen (for example, labeling a Speed Dial button).

When the **Phone Screen on Calling?** option is set to **No** answering an incoming call has no impact on the application screen displayed, although the top display line will provide an appropriate message.

To change **Phone Screen on Calling**:





1. Press  **Options**,  **Applications Options** and then select the **Phone Screen on Calling** feature button. It will toggle between **Yes** and **No**.
2. Select  **Save**.
(To restore the previous setting without changing it, press  **Cancel**.)

After saving or canceling, the first Options main screen is displayed.

Display Call Timers

This action controls whether the duration of the current call is displayed or not. If set to **Yes**, the duration of the current call is displayed on the call appearance key. If set to **No**, the call duration will not be displayed.

To change the **Display Call Timers** status:





1. Press  **Options**,  **Applications Options**,  and then select the **Display Call Timers?** feature button. It will toggle between **Yes** and **No**.
2. Select  **Save**.
(To restore the previous setting without changing it, press  **Cancel**.)

After saving or canceling, the first Options main screen is displayed.

Message Display Rate

When the IP Office sends messages to your phone that are longer than the display area, the first part of the message is presented for a specific time interval. The second part of the message is then displayed for a specific time interval. The Message Display Rate can be either **Fast** (display interval is 2 seconds) or **Slow** - default (display interval is 3 seconds).

To change **Message Display Rate**:





1. Press  **Options**,  **Applications Options**,  and then select the **Message Display Rate** feature button. This will toggle between **Fast** and **Slow**.
2. Select  **Save**.
(To restore the previous setting without changing it, press  **Cancel**.)

After saving or canceling, the first Options main screen is displayed.

Visual Alerting

When this option is set to **Yes** (the default), your phone rings and your voice message indicator light flashes to alert you to an incoming call. When set to **No**, ringing is the only notification of an incoming call.





To change **Visual Alerting**:

1. Press  **Options**,  **Applications Options**,  and then select the **Visual Alerting** feature button. It will toggle between **No** and **Yes**.
2. Select  **Save**.
(To restore the previous setting without changing it, press  **Cancel**.)

After saving or canceling, the first Options main screen is displayed.

Personal Ringing





You can choose from among eight different ring patterns. This alters the tone and style of ringing used by the 5620, e.g. the number of rings will still vary according to the type of call.

1. Press  **Options** and select  **Personal Ringing**.
A menu with the current ring pattern appears.
2. To select a ringing pattern use press **Pattern 1 to 8**.
You will hear the selected ringing pattern.
3. When you have selected a ringing pattern, press  **Save**. You will hear a confirmation tone and be returned to the options menu.
4. If you want to return to the options menu without changing the ring pattern, press  **Cancel**.

View IP Settings

Views of telephone and system information are available from this screen. A user normally does not need to view this information, however your System Administrator may ask you to report certain values from any of the status screens in the event of problems.

The status screen data can be viewed, **but cannot be changed** from your 5620.

1. Press  **Options** and then select  **View IP Settings**.
2. There are two pages of display. Use   and select from:
 - **IP Addresses**
 - **Quality of Service**
 - **Interfaces**
 - **Miscellaneous**.
3. To return to the first View IP Settings screen, press  **Return**.

Each option is described in the sub-sections that follow.

IP Address Settings

IP (Internet Protocol) address information identifies certain components and connections. The IP Address information includes the location (address) of your phone on the IP Office unit, the location and port (connection) of the IP Office itself, the call routing and mask addresses, and the identification of the File Server with which your telephone interacts. Although technical in nature, having this information available and knowing how to get to it can assist your System Administrator in tracking questions about or problems with phone functions or connections.

Quality of Service (QoS) Information

QoS refers to a number of mechanisms used to improve audio quality over the network.

Phone Interface







Your phone interfaces with several system hardware devices and software. This screen provides information about three of the main interfaces.

Miscellaneous Information

The miscellaneous status screens provide additional information about your telephone and its connections.

Adjusting the Display Contrast

You can adjust the contrast level on the telephone display. You can choose from among fifteen levels of contrast.





1. Press  **Options** and then select  **Contrast Control**
2. Use either the  or  key to adjust the level of contrast.
3. When the contrast is set as required, either:
 - Save and return to the options menu by pressing  **Save**.
 - Press  **Cancel** to return to the options menu.

Logging off the 5620 IP Telephone

Allows you to log your telephone off to prevent unauthorized use during an absence, or for privacy purposes

CAUTION: Logging off deletes all Call Log entries and returns any options you may have changed to their default values.

To log your phone off:

1. Press  **Options** and  **Log off**.
2. Select  **Yes** to un-register your phone from the IP Office, delete all Call Log entries and returns any options you may have configured to their default values.
3. Selecting  **No** returns you to the main Option menu; your phone remains logged on to the network and your Call Log and options values remain unchanged.

To log back on:

1. The display will show Ext.=xxx in the top row. Simply press **#** and enter your password (consult your System Administrator).

Backup/Restore Options

The 5620 IP Telephone's backup/restore options require set up and configuration by the system administrator prior to use. These options are displayed on the telephone screen via the Options button, but will only be amendable if they have been configured by the system administrator.

The backup/restore options provide the ability to:

- Back up your options/preference settings, your Speed Dial button labels, names, and numbers automatically whenever you save a change to any one of those settings or buttons. Automatic backup protects this data against system failure.
- Restore options settings and Speed Dial button labels, names and numbers following a phone failure or replacement.
- Establish or modify FTP (File Transfer Protocol) settings such as the network server address, directory path for saving backed-up data, and a User ID and Password for server access via your phone.
- Verify whether an automatic backup has occurred.

Because each telephone system has unique characteristics and settings, modifying the Backup/Restore options generally require the assistance of the System Administrator. For example, it is unlikely that a 5620 IP Telephone user would know the specific Server IP Address to enter when setting up FTP parameters. Hence:

Due to the technical nature of this feature, it is highly recommended that this feature is only used by the System Administrator.

Changing Feature Key Labels







This action is not supported with the 5620 IP Telephone on Avaya IP Office System.

Language Selection

When the 5620 telephone is first installed, it is set to display screen text in English. You can select the language that you would prefer from the following:



English, German (Deutsch), French (Français), Spanish (Español), Italian (Italiano), Dutch (Nederlands), Portuguese (Português) or Japanese (Katakana characters).

Note: This does not alter your user language setting on the telephone system.





1. Press  **Options**,  and  **Language**.
A menu listing the available languages appears.
2. Press the  or  key next to the language required. You are asked in the original language “Are you sure?” with the same message in the new language below.
3. Do one of the following:
 - To return to the options menu without saving any changes, press  **Return**.
 - To save the settings and return to the options menu, press  **Yes** (which is displayed in both the original and the selected language).

Function Keys



Overview of Function Keys

Both the left hand  and right hand  Function Keys can be used to access a range of features. The display adjacent to the key shows the feature name.

Some of these features are default features supported by all 5620 telephones (e.g. the call appearance lines labeled a=, b= and c=). Others are features that **can only be programmed by the System Administrator** for your telephone system.

The main screen has three pages. This means that the six  and  Function Keys on the first and last page and the 12 Function keys on the second page can be used for up to 24 features. To move between pages use the  and  keys.

In the following example:

- The first three keys have been set (default setting) as call appearance lines. See Call Appearance Keys on page 8.
- Keys 4 and 5 have been set to access the **Admin** and **Admin1** programmable functions. See Function Key Programming on page 28.
- Key 6 has been set to monitor system park slot 1. The highlighted text indicates that a call is currently parked in slot 1. See Park - Park (#) on page 47.
- Key 7 has been set to the **SAC** (Send All Calls) function. In this example all calls will be sent to extension 104 when the function is activated. See SAC - Send All Calls on page 53.
- Key 8 has been set to **VMOn**, a function which toggle use of the user's voicemail mailbox on/off. The highlighted text indicates that this function is currently on. See VMOn - Voicemail On on page 55.
- Pressing either  or  will display the other pages of programmed functions set for this phone.

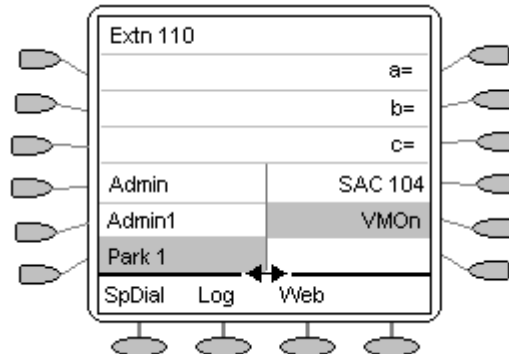

Programming Your Own Functions:

If the phone has been setup with either or both the **Admin** and **Admin1** features assigned to display keys, you can select and program your own feature choices against other keys. See Function Key Programming on page 28.

Function Key Programming

If any one of the keys on the telephone is programmed with an **Admin** or **Admin 1** feature, it allows you to program further features against other function keys. Both **Admin** and **Admin1** are allocated to your function keys by your System Administrator and would appear on a menu screen that is similar to the following:

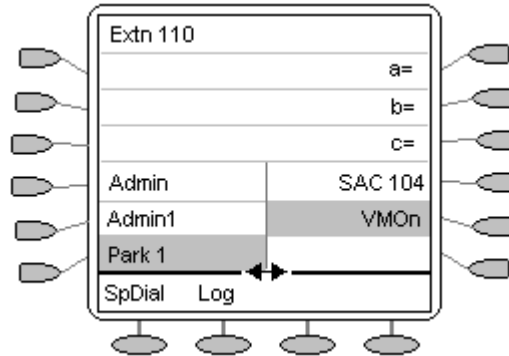

The two tables below list the user programmable features available for **Admin** and **Admin1** respectively. For full details of how each feature works see Function Key Features on page 30.

Admin: The programmable functions available via an **Admin** key.

Name	Description	Toggles	Data
Acct	Account Code Entry	No	Optional
AD	Abbreviated Dial	No	Yes
Admin	Self-Administer	No	No
AutCB	Automatic Callback	Yes	No
CFrwd	Call Forwarding All	Yes	Optional
CPark	Call Park	Yes	Optional
CPkUp	Call Pickup	No	No
Dir	Directory	No	No
DPkUp	Directed Call Pickup	No	Yes
Drop	Drop	No	No
GrpPg	Group Paging	No	Yes
HdSet	Headset Toggle	Yes	No
HfAns	Internal Auto-Answer	Yes	No
HGNS+	Set Hunt Group Night Service	Yes	Yes
Park	Call Park to Other Extension	No	Yes
Prog	Abbreviate Dial Program	No	Yes
RngOf	Ringer Off	Yes	No
SAC	Send All Calls	Yes	No
Spres	AD Suppress	Yes	No
Timer	Timer	Yes	No
TmDay	Time of Day	Yes	No

In addition to the above, there is a key labeled **Exlp?** This key enables you to change the display from the shorthand version displayed at default to a longhand version of your own. See Shorthand Programming Mode on page 30 and Longhand Programming on page 30 respectively.

Admin1: The programmable functions available via an **Admin 1** key.

Name	Description	Toggles	Data
Park	Park	No	Yes
<User>	User	No	Yes
<Group>	Group	No	Yes
<Number>	Dial	No	Yes
Flash	Hook Flash	No	No

Shorthand Programming Mode

1. Press  **Admin** or **Admin 1**.
See Function Key Programming on page 28.
2. The **Admin** or **Admin1** menu appears as follows:

Admin Pages

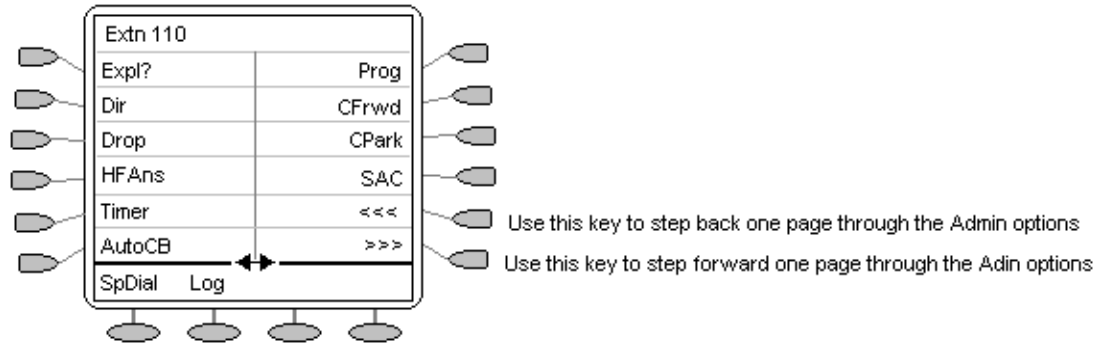



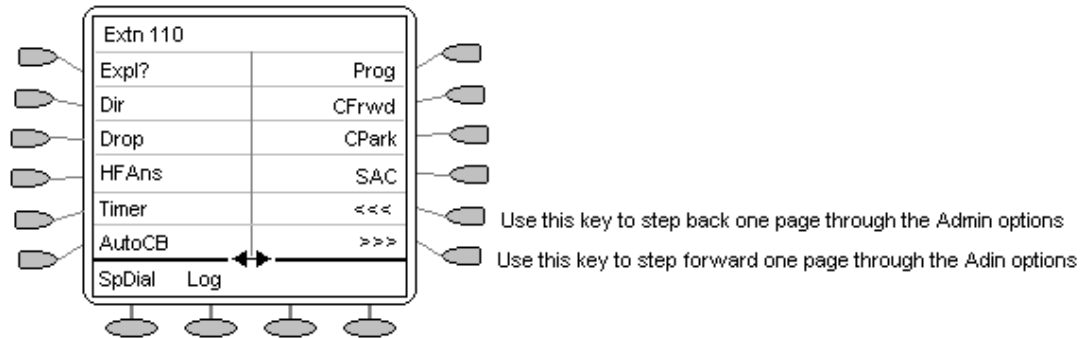

With the exception of **Expl?**, the names shown are the features that you can assign to soft keys. When **Admin** has been selected you can display the full name of the feature by pressing **Expl?**. (see Longhand Programming on page 30).





Admin1 Page











Similarly, when **Admin1** is pressed, you can assign any one of the functions shown to a soft key.





3. On the **Admin** pages, use the >>> or <<< keys to move through the feature pages.
4. When the function required is shown, press the  key adjacent to its name.
5. If the function requires some data to be entered, [is shown at the top of the display. Enter the data using the normal telephone keypad.
6. Select the display key against which to program the new function by pressing that  or  key. Use the  or  keys to move through the pages.

CAUTION: Do not select the slot used for the **Admin** function. Replacing this function will lock the phone for further programming until reset through the telephone system by your System Administrator.



7. If the display slot is not already used, the display shows **BUTTON PROGRAMMED!**.
 - Press  **EXIT** to end programming
 - or
 - Press **Cont**  to continue programming other functions.
8. If the display slot already has a programmed function, the display shows **FEATURE ON BUTTON**.
 - Press **Repla**  to replace that existing function with the one just programmed. The display then shows **BUTTON PROGRAMMED!** As in step 8 above.
 - Press **Keep**  to keep the existing function and forget the function just programmed.
 - Press **Delete**  to delete the existing function and forget the function just programmed.

Longhand Programming

1. Press  **Admin**. See Function Key Programming on page 28.
2. Pressing **Expl?** . The longhand text for the function is shown at the top of the display.
3. Press  **Next** or >>> until the required feature required is shown, then press  **Select**. (You can also use <<< to step back through the list of Admin functions).
4. If the function requires some data to be entered, [is shown at the top of the display. Enter the data using the normal telephone keypad.
5. Select the display key against which to program the new function by pressing that  or  key. Use the  or  keys to move through the pages.

CAUTION: Do not select the slot used for the **Admin** function. Replacing this function will lock the phone for further programming until reset through the telephone system by your System Administrator.
6. If the display slot is not already used, the display shows **BUTTON PROGRAMMED!**
 - Press  **EXIT** to end programming
 - or
 - Press **Cont**  to continue programming other functions.
7. If the display slot already has a programmed function, the display shows **FEATURE ON BUTTON**.
 - Press **Repla**  to replace that existing function with the one just programmed. The display then shows **BUTTON PROGRAMMED!** As in step 8 above.
 - Press **Keep**  to keep the existing function and forget the function just programmed.
8. Press **Delete**  to delete the existing function and forget the function just programmed.

Function Key Features

This section lists the features that can be programmed against  and  Function Keys. Both the shorthand and longhand names are shown. The shorthand name is the name that is displayed next to the programmed key, along with any data programmed for the feature.



All of the following functions can only be programmed onto your 5620 by your System Administrator.

Were applicable the command path used by the System Administrator is shown, for example:

```
[User | Digital Telephony | Emulation | Directory].
```

Dial (#)

Automatically dials the displayed number.

This function requires entry of the number to dial when programmed. The number is then displayed next to the  key. This function can be programmed through the phone by the user using an  **Admin 1** key.

Pressing the **Dial**  key dials the associated number.



```
[User | Digital Telephony | Dial]
```





See also:

- AD - Abbreviated Dial (!) on page 32.
- Prog - Abbreviated Dial Program (!) on page 49.

Group (#)

Answer or clear calls ringing a specific group.



This function requires entry of the group number (allocated by your System Administrator). When programmed, the group name is then displayed next to the  key. This function can be programmed through the phone by the user using an  **Admin 1** key and the group number.



A  appears against the group when calls to that group are ringing. Pressing  displays details of one of those calls and options to drop (**Drop** ) the call, answer the call (**Answr** ) or exit the group monitor ( **EXIT**).

[User | Digital Telephony | Group]

User (#)

See the status of a specific user, call that user and pick-up calls to that user.

When programmed by your System Administrator (on the IP Office), the user name is entered. That name is then displayed next to the  key. This function can also be programmed through the phone by the user using an  **Admin 1** key and then the user number. Pressing the  key calls the user.

When the user is called the user name is underlined with a  symbol beside it. Press the  key next to the name. **DkPickup** appears against a call appearance key. To pick up the call press this key.

If the System Administrator has setup group monitoring of the same user, pressing the  user key when the user is busy on a call displays several options. These are **Drop** (end the user's call), **Listn** (listen to the call), and **Aquir** (takeover the call). If the System Administrator has not setup group monitoring, then the options shown are **Call**, **Message**, **Vmail** and **CallB**.

[User | Digital Telephony | User]

Absnt - Set Absent Text

Set the users current absence message setting.

This function is currently not supported on the 5620 telephone.

Acct - Account Code Entry (!)

Make a call using an account code or enter an account code during a call.

This function can be programmed with or without data. This function can be programmed through the phone by the user using an  **Admin** key.

If programmed with data, the account code entered when programmed must match a valid account code set on the telephone system. The  **Acct** key displays that number.

If programmed without data, **ENTER ACCOUNT** is displayed after  **Acct** is pressed. Enter an account code and press **Set** .

If the account code entered does not match a valid account code set on the telephone system, **REENTER ACCOUNT** is displayed.

An  **Acct** key can be pressed before or during a call.

[User | Digital Telephony | Emulation | Account Code Entry]

AD - Abbreviated Dial (!)

Dial the displayed number.

This function requires entry of a number to dial when programmed. The  **AD** key displays that number. This function can be programmed through the phone by the user.

The number does not have to be a complete number, the user can dial additional digits after pressing  **AD**. * and # can be entered in the number to match IP Office shortcodes.

[User | Digital Telephony | Emulation | Abbreviated Dial]



See also:

- Dial (#) on page 30.
- Prog - Abbreviated Dial Program (!) on page 49.

Admin - Self-Administer (!)

Access menus for programming functions against display keys.

This function can be programmed with or without data. If programmed with a setting of **1**, the key accesses a different set of functions. See Function Key Programming on page 28. This function can be programmed through the phone by the user using an existing  **Admin** key.

The  **Admin** key gives access to the menus for programming functions against  and  keys.

[User | Digital Telephony | Emulation | Self-Administer]

Apear - Appearance

Add a display line for call appearances with symbols being displayed for Incoming Calls, Connected and On Hold. See **Error! Reference source not found.** on page **Error! Bookmark not defined.**

This function does not require any data entered when programmed. However it is normal to enter some text such as **a=**, **b=** and so on for each call appearance key.



This function cannot be programmed through the phone by the user.

[User | Digital Telephony | Emulation | Appearance]

AutCB - Automatic Callback (!)

Sets a callback when free on busy extensions and callback when next used on unanswered extensions.

This function does not require any data entered when programmed. This function can be programmed through the phone by the user using an  **Admin** key.

When the called target extension does not answer or is busy, pressing  **AutCB** sets a callback on that extension. Whilst the callback is set, **AutCB** is shown with a  symbol. Pressing  **AutCB** again cancels the callback.

Hence, when the callback target extension becomes free or is next used, pressing  starts a call to that extension.

[User | Digital Telephony | Emulation | Automatic Callback]

See also:

- RBak - Cancel Ringback When Free on page 50.
- RBak+ - Ringback When Free on page 50.

Busy - Busy

Sets the extension as being busy. This feature is not applicable when working with multiple Call Appearance lines as all the call appearance lines must be in use before this function becomes active.

This function does not require any data entered when programmed. This function cannot be programmed through the phone by the user.

The  **Busy** key sets the extension as busy to callers. If a forward on busy number is set, it is followed (see FwBNo - Forward On Busy Number on page 39). Otherwise calls go to voicemail if on or receive busy tone if internal and ringing if external.

To return the extension from busy, press  **Busy** and then  **Speaker**.

[User | Digital Telephony | Advanced | Busy | Busy]

BusyH - Busy On Held

Switch the users busy on held status on/off.

This function requires data entered when programmed. Enter 0 for **off** or 1 for **on**.

This function cannot be programmed through the phone by the user.

Pressing  **BusyH** switches the user's 'busy on held' state to either on or off as indicated by the data value. When on, if the user has a call on hold, new callers receive busy tone (ringing if analogue) or are diverted to voicemail (if enabled), rather than ringing the user. This function also overrides call waiting indication when the user has a call on hold.

[User | Digital Telephony | Advanced | Busy | Busy On Held]



CFrwd - Call Forwarding All (!)



Switch call forwarding on/off and set the forwarding number.

This function can be programmed with or without a target forwarding number. This function can be programmed through the phone by the user using an  **Admin** key.

If programmed with a forwarding number, that number is shown next to **CFrwd**.

Pressing **CFrwd** switches on forwarding to that number.

If programmed without a forwarding number, when  **CFrwd** is pressed, the user's current forwarding number setting is shown. Change the number using the telephone keypad and <<<  to backspace. When the number set as required press **Done** .

When call forwarding is on, **CFrwd** is shown with a  symbol and **D** (Diverted) is shown at the top of the display. To switch call forwarding off, press  **CFrwd** again.

[User | Digital Telephony | Emulation | Call Forwarding All]

See also:

- FwNOn - Forward On No Answer On on page 41
- FwUOn - Forward Unconditional On on page 41.
- FwdNo - Forward Number on page 40.
- FwdH+ - Forward Hunt Group Calls On on page 40

ClrCW - Clear CW

Clears the current connected call and connects any waiting call. This feature is not applicable when working with multiple Call Appearance lines.

This function does not require any data entered when programmed. This function cannot be programmed through the phone by the user.

Pressing  **ClrCW** disconnects the extension's current call and connects any waiting call.

[User | Digital Telephony | Advanced | Call | Clear CW]

CnfRV - Conference Meet Me

Allows the extension to join a specified conference.

This function requires the conference number to be entered when programmed. That number is then shown next to **CnfRV**. This function cannot be programmed through the phone by the user.

Pressing  **CnfRV** places the extension into the specified conference. Note that the number of conference parties allowed at any time is determined by the telephone system.

[User | Digital Telephony | Advanced | Call | Conference Meet Me]

Conf+ - Conference Add

Places all calls held by the extension into a conference.

This function does not require any data entered when programmed. This function cannot be programmed through the phone by the user.

Pressing  **Conf+** places the extension and any calls it has put on hold into a conference. This function will not work if the extension has a current call.

[User | Digital Telephony | Advanced | Call | Conference Add]

CPark - Call Park (!)

Park the current call.

This function can be programmed with or without data. This function can be programmed through the phone by the user using an  **Admin** key.

If programmed with data, the number entered is shown next to the  **CPark** key and is the number assigned to the parked call.

If programmed without data, the key displays just **CPark**. Calls parked using this key are assigned a number based on the parking extension's number. For example, extension 290's first parked call is numbered 2900, its next 2901 if 2900 is still parked and so on. If calls are parked using this key, **CPark** is shown with a  symbol. Pressing the key again displays the user's parked calls and allows them to be retrieved. Parked calls are retrieved with the **Ride** function (see page 52).

If not retrieved elsewhere, a parked call will recall to the parking extension after a set time.

[User | Digital Telephony | Emulation | Call Park]

See also:

- Park - Park (#) on page 47.
- Park - Call Park to Other Extension (!) on page 48.
- Ride - Ride Call on page 52.

CPkUp - Call Pickup (!)

Answer a call ringing elsewhere on the telephone system.

This function does not require any data entered when programmed. This function can be programmed through the phone by the user using an  **Admin** key.

The  **CPkUp** call answers (pickup) any call currently ringing on the telephone system.

Note: We recommend that this function is only used on systems with a small number of users all in one area. Use of this function on larger system may lead to confusion.

[User | Digital Telephony | Emulation | Call Pickup]

See also:

- PickA - Call Pickup Any on page 49.
- PickG - Call Pickup Group on page 49.
- PickM - Call Pickup Members on page 49.

CWOff - Call Waiting Off

Switches call waiting for the extension off.

This function does not require any data entered when programmed. This function cannot be programmed through the phone by the user.



The  **CWOff** key switches call waiting for the extension off.

[User | Digital Telephony | Advanced | Call | Call Waiting Off]

CWOn - Call Waiting On

Switches call waiting for the extension on/off.

This function does not require any data entered when programmed. This function cannot be programmed through the phone by the user.

The  **CWOn** key toggles call waiting on/off. When call waiting is on, **CWOn** is shown with a  symbol. When call waiting is on and the extension is on a call, any additional call receives ringing rather than busy tone.

[User | Digital Telephony | Advanced | Call | Call Waiting On]

CWSus - Call Waiting Suspend

Suspend the current call at the exchange and answer the waiting call.

This function is not supported in the USA.

If no slot number is specified when the function is programmed, exchange slot 0 is used. This function cannot be programmed through the phone by the user.

Pressing  **CWSus** is only supported if the exchange provides a Q.931 suspend call facility.

[User | Digital Telephony | Advanced | Call | Call Waiting Suspend]

See also:

- Resum - Resume Call on page 52.

DCW - Dial CW

Allows the user to force another extension to have call waiting mode on for the duration of a call attempt. This function is not supported in the USA.

This function requires the target extension number to be entered when programmed. That number is then shown next to **DCW**. This function cannot be programmed through the phone by the user.

Normally, if the target extension is on a call and doesn't have call waiting on, any new call will receive busy tone or be diverted to voicemail. Pressing  **DCW** will cause the target extension to receive call waiting indication and allow the caller to hear ringing until answered.

[User | Digital Telephony | Advanced | Dial | Dial CW]

See also:



- Queue - Call Queue on page 50.

Dir - Directory (!)

Accesses the telephone system directory.

This function does not require any data entered when programmed. This function can be programmed through the phone by the user using an  **Admin** key.

Pressing  **Dir** displays a number of options.

- **INDeX**  - Search for a matching extension user name on the telephone system.
- **Group**  - Search for a matching group name on the telephone system.
- **Extrn**  - Search for a name match in the telephone systems directory of external numbers.

[User | Digital Telephony | Emulation | Directory]

Dirct - Dial Direct

Connects a call to the target extension without any ringing.



This function requires the target extension number to be entered when programmed. That number is then shown next to **Dirct**. The target extension must be capable of auto-answering. This function cannot be programmed through the phone by the user.

[User | Digital Telephony | Advanced | Dial | Dial Direct]

DNDOn - Do Not Disturb On

Puts the extension into 'do not disturb' (no calls) mode.

This function does not required any data to be entered when programmed. This function cannot be programmed through the phone by the user.

Pressing  **DNDOn** toggles the extension's do not disturb state. When on, **DNDOn** is shown with a  symbol and the display includes an **N** (No calls).

[User | Digital Telephony | Advanced | Do Not Disturb | Do Not Disturb On]

See also:

- SAC - Send All Calls (!)on page 53.

DNDOf - Do Not Disturb Off

Takes the extension out of 'do not disturb' (no calls) mode.

This function does not require any data to be entered when programmed. This function cannot be programmed through the phone by the user.

Pressing  **DNDOf** switches the extension's do not disturb state off.

[User | Digital Telephony | Advanced | Do Not Disturb | Do Not Disturb Off]

DNDX+ - Do Not Disturb Exception Add

Adds the specified number to the extension's do not disturb exception list.

This function requires entry of the calling number when programmed. That number is then shown next to **DNDX+**. This function cannot be programmed through the phone by the user.

Pressing  **DNDX+** adds the set number to the extension's do not disturb exception list. That number can then call the extension and transfer calls to the extension even when the extension is in do not disturb mode.

[User | Digital Telephony | Advanced | Do Not Disturb | Do Not Disturb Exception Add]

DNDX- - Do Not Disturb Exception Delete

Removes the specified number from the extension's do not disturb exception list.

This function requires entry of the calling number when programmed. That number is then shown next to **DNDX-**. This function cannot be programmed through the phone by the user.

Pressing  **DNDX-** removes the set number from the extension's do not disturb exception list. That number can then call the extension and transfer calls to the extension even when the extension is in do not disturb mode.

[User | Digital Telephony | Advanced | Do Not Disturb | Do Not Disturb Exception Del]

DPkUp - Directed Call Pickup (!)

Answer a call currently ringing at a specified user or group.

This function can be programmed with or without a target extension or group number. This function can be programmed through the phone by the user using an  **Admin** key.

If programmed with a target number, the  **DPkUp** key displays that number. When a call is ringing at that extension or group, press  **DPkUp** to answer (pick up) that call.

If programmed without a target number, pressing  **DPkUp** allows the user to enter the target number for that pickup attempt.

[User | Digital Telephony | Emulation | Directed Call Pickup]

Drop - Drop (!)

Clears a current calls.

This function does not require any data entered when programmed. This function can be programmed through the phone by the user using an **Admin** key.

For a call in progress, pressing **Drop** disconnects the caller.

When drop is used, silence is returned to the user rather than dial tone. This is intended operation, reflecting that **Drop** is mainly used by call center headset users.

[User | Digital Telephony | Emulation | Drop]

DTone - Secondary Dial Tone

Return secondary dial tone to the user.

This function is currently not supported on the 5620 telephone.

Emrgy - Dial Emergency

Dials a specified number regardless of any call barring applied to the user.

This function requires entry of a number to dial when programmed. That number is then shown next to **Emrgy**. This function cannot be programmed through the phone by the user.

[User | Digital Telephony | Advanced | Dial | Dial Emergency]

Flash - Flash Hook (#)

Send a hook flash signal to the currently connected line.



This function does not require any data entered when programmed. This function cannot be programmed through the phone by the user. This function can be programmed through the phone by the user using an  **Admin 1** key.

[User | Digital Telephony | Advanced | Miscellaneous | Flash Hook]

FoITo - Follow Me To

Forwards calls from this extension to the specified target.

This function requires the target extension to be entered when programmed. The extension number is then shown next to **FoITo**. This function cannot be programmed through the phone by the user.

Pressing  **FoITo** sets the extension's Follow Me To number to the specified extension and switches follow me use on. Whilst on, **FoITo** is shown with a  symbol. Press  **FoITo** again to switch off.

[User | Digital Telephony | Advanced | Follow Me | Follow Me To]

FwBNo - Forward On Busy Number

Sets the extensions forwarding number for use with forward on busy and forward on no answer.

This feature requires the target number to be entered when programmed. The number set is shown next to **FwBNo**. This function cannot be programmed through the phone by the user.

Pressing  **FwBNo** set the extension's forwarding number to that specified by the key pressed.

[User | Digital Telephony | Advanced | Forward | Forward On Busy Number]

See also:

- FwBOn - Forward On Busy On on page 39
- FwNOn - Forward On No Answer On on page 41.

FwBOn - Forward On Busy On

Switches the extension to forward on busy on.

Note: When Call Appearance keys have been allocated, all the call appearance lines must be in use before this function becomes active.

This function does not required any data to be entered when programmed. This function cannot be programmed through the phone by the user.

Pressing  **FwBOn** toggles the extension's forward on busy state and can also be used in conjunction with FwBOf - Forward On Busy Off on page 39. When on, **FwBOn** is shown with a **▲** symbol. When on, calls are forwarded to the extension's forward on busy number.

[User | Digital Telephony | Advanced | Forward | Forward On Busy On]

See also:

- FwBNo - Forward On Busy Number on page 39.

FwBOf - Forward On Busy Off

Switches the extension to forward on busy off. Used in conjunction with FwBOn - Forward On Busy On on page 39

This function does not required any data to be entered when programmed. This function cannot be programmed through the phone by the user.

Pressing  **FwBOf** switches the extension's use of forward on busy off.



[User | Digital Telephony | Advanced | Forward | Forward On Busy Off]

FwdH+ - Forward Hunt Group Calls On

Switches the extension to forward hunt group calls it receives.

Note: Calls are only forwarded when forward unconditional (see CFrwd - Call Forwarding All (!) on page 33) or FwUOn - Forward Unconditional On on page 41 is also on.

This function does not required any data to be entered when programmed. This function cannot be programmed through the phone by the user.

Pressing  **FwdH+** toggles the feature on/off. When on, **FwdH+** is shown with a  symbol. Can also be used in conjunction with FwdH- - Forward Hunt Group Calls Off on page 40.

[User | Digital Telephony | Advanced | Forward | Forward Hunt Group Calls On]

FwdH- - Forward Hunt Group Calls Off

Switches the extension to forward unconditional off.

This function does not required any data to be entered when programmed. This function cannot be programmed through the phone by the user.

Pressing  **FwdH-** switches the extension's use of forward hunt group calls off. Can also be used in conjunction with FwdH+ - Forward Hunt Group Calls On on page 40

[User | Digital Telephony | Advanced | Forward | Forward Hunt Group Calls Off]

FwdNo - Forward Number

Sets the extension's forwarding number for use when forwarding all calls.

This feature requires the target number to be entered when programmed. The number set is shown next to **FwdNo**. This function cannot be programmed through the phone by the user.

Pressing  **FwdNo** set the extension's forwarding number to that specified by the key pressed.

Also See:

- FwBOn - Forward On Busy On on page 39
- FwUOn - Forward Unconditional On on page 41

[User | Digital Telephony | Advanced | Forward | Forward Number]

FwdOf - Cancel All Forwarding

Switch off all call forwarding.

This function does not require any data entered when programmed. This function cannot be programmed through the phone by the user.

Pressing  **FwdOf** switches off all the extensions call forwarding options. It does not delete the forwarding number settings.

[User | Digital Telephony | Advanced | Call | Cancel All Forwarding]

FwNOn - Forward On No Answer On

Switches the extension to forward on no answer on.

This function does not required any data to be entered when programmed and cannot be programmed through the phone by the user.

Pressing  **FwNOn** toggles the extension's forward on no answer state. When on, **FwNOn** is shown with a ◀ symbol. When on, calls are forwarded to the extension's forward on busy number (see FwBNo - Forward On Busy Number on page 39).

[User | Digital Telephony | Advanced | Forward | Forward On No Answer On]

FwNOF - Forward On No Answer Off

Switches the extension to forward on no answer off.

This function does not required any data to be entered when programmed. This function cannot be programmed through the phone by the user.

Pressing  **FwNOF** switches the extension's use of forward on no answer off. Can also be used in conjunction with FwNOn - Forward On No Answer On on page 41.

[User | Digital Telephony | Advanced | Forward | Forward On No Answer Off]

FwUOn - Forward Unconditional On

Switches the extension to forward all its calls except hunt group calls.

Note: When Call Appearance keys have been allocated, all the call appearance lines must be in use before this function becomes active.

This function does not required any data to be entered when programmed. This function cannot be programmed through the phone by the user.

Pressing  **FwUOn** toggles the extension's forward on busy state. When on, **FwUOn** is shown with a ◀ symbol and the display includes a **D**. When on, calls are forwarded to the extension's forward number (see FwBNo - Forward On Busy Number on page 39).

[User | Digital Telephony | Advanced | Forward | Forward Unconditional On]

FwUOf - Forward Unconditional Off

Switches the extension's forward unconditional off.



This function does not required any data to be entered when programmed. This function cannot be programmed through the phone by the user.

Pressing  **FwUOf** switches the extension's use of forward unconditional off. Can also be used in conjunction with FwUOn - Forward Unconditional On on page 41.

[User | Digital Telephony | Advanced | Forward | Forward Unconditional Off]

GrpPg - Group Paging (!)

This function can be programmed with or without a target extension or group number. This function can be programmed through the phone by the user using an  **Admin** key.

If programmed with a target number, the  **GrpPg** key displays that number. When  **GrpPg** is pressed, it will make a paging call to that number.

If programmed without a target number, the number must be dialed after the user presses  **GrpPg**.

[User | Digital Telephony | Emulation | Group Paging]

HdSet - Headset Toggle (!)

This function does not require any data entered when programmed. This function can be programmed through the phone by the user using an  **Admin** key.

The programmed key will then switch the phone between handset and headset operation. When on, **HdSet** is shown on a dark background.

There is no linkage between a programmed **HdSet** key and the phone's  **HEADSET** key.

[User | Digital Telephony | Advanced | Miscellaneous | Headset Toggle]

Here- - Follow Me Here Cancel

If another extension has follow me set to this extension, switches off the follow me action.

This function requires the original target extension to be entered when programmed. The extension number is then shown next to **Here-**. This function cannot be programmed through the phone by the user.

Pressing  **Here-** cancels the use of follow me at the target extension.

[User | Digital Telephony | Advanced | Follow Me | Follow Me Here Cancel]

Here+ - Follow Me Here

Forwards calls to the target extension to this extension.

This function requires the original target extension to be entered when programmed. The extension number is then shown next to **Here+**. This function cannot be programmed through the phone by the user.



Pressing  **Here+** sets the target extension's Follow Me To number to that this extension. Calls to the target extension are then forwarded to this extension.

[User | Digital Telephony | Advanced | Follow Me | Follow Me Here]

HfAns - Internal Auto-Answer (!)

Answers internal calls after a single ring.

This function does not require any data entered when programmed. This function can be programmed through the phone by the user using an  **Admin** key.

The  **HfAns** key toggles internal auto-answer on/off. When on, **HfAns** is shown with a  symbol.

[User | Digital Telephony | Emulation | Internal Auto Answer]



See also:



- RngOf - Ringer Off (!) on page 52.
- CWOn - Call Waiting On on page 35.

HGENa - Hunt Group Enable

Sets the extension's membership of a group or groups as enabled. This function **does not** take the Hunt Group In/Out of Service.

This function can be programmed with or without a target group number. This function cannot be programmed through the phone by the user.

If programmed without a group number, pressing  **HGENa** toggles all the extension's group memberships to either enabled or disabled. A  is shown next to  **HGENa** when the group memberships are enabled.

If programmed with a group number, that number is shown next to  **HGENa**. Pressing  **HGENa** will enable the extension's membership of that group. In this mode the key does not toggle.

When enabled, **G** is shown on the display and the extension will receive group calls.

[User | Digital Telephony | Advanced | Hunt Group | Hunt Group Enable]

See also:

- HGNS+ - Set Hunt Group Night Service (!) on page 43.
- HGOS+ - Set Hunt Group Out of Service44 on page.
- HGDis - Hunt Group Disable on page 43.

HGDis - Hunt Group Disable

Sets the extension's group membership as disabled. This function **does not** take the Hunt Group Out of Service.

This function can be programmed with or without a target group number. This function cannot be programmed through the phone by the user.

If programmed without a group number, pressing  **HGDis** disables all the extension's group memberships.

If programmed with a group number, pressing  **HGDis** disables just the extension's membership of that group.

[User | Digital Telephony | Advanced | Hunt Group | Hunt Group Disable]

HGNS+ - Set Hunt Group Night Service (!)

Put a specific hunt group into night service mode.

This function requires the hunt group number to be entered when programmed. The hunt group number is then shown next to **HGNS+**. This function can be programmed through the phone by the user using an  **Admin** key.

Pressing  **HGNS+** puts the hunt group into night service. Group calls then go to its night service fallback group if set or, if not answered, to voicemail.

[User | Digital Telephony | Advanced | Set | Set Hunt Group In Service]

HGNS- - Clear Hunt Group Night Service

Returns a hunt group that has been manually put into night service back to normal service. Used with HGNS+ - Set Hunt Group Night Service (!) on page 43.

This function requires that the hunt group number is entered when programmed. This function cannot be programmed through the phone by the user.

The hunt group number is shown next **HGNS-**. Pressing  **HGNS-** puts the group back into normal service if in night service.

[User | Digital Telephony | Advanced | Call | Clear Hunt Group Night Service]

HGOS+ - Set Hunt Group Out of Service

Put a specific hunt group out of service mode.

This function requires the hunt group number to be entered when programmed. The hunt group number is then shown next to **HGOS+**. This function cannot be programmed through the phone by the user.

Pressing  **HGOS+** puts the hunt group out of service. Group calls then go to its out of service fallback group if set or, if not answered, to voicemail.

[User | Digital Telephony | Advanced | Set | Set Hunt Group Out Service]

HGOS- - Clear Hunt Group Out of Service

Returns a hunt group that has been manually put into out of service back to normal service. Used with HGNS+ - Set Hunt Group Night Service (!) on page 43.

This function requires that the hunt group number is entered when programmed. This function cannot be programmed through the phone by the user.

The hunt group number is shown next **HGOS-**. Pressing  **HGOS-** puts the group back into normal service if in night service.

[User | Digital Telephony | Advanced | Call | Clear Hunt Group Out Of Service]

Hold - Hold Call

Place the current call on hold at the central office. This function is not supported in the USA.

If no exchange slot number is specified when the function is programmed, central office slot 0 is used.

Pressing  **Hold** is only supported if the central office provides a Q.931 hold facility. It is not the same as local hold provided by the IP Office.

[User | Digital Telephony | Advanced | Hold | Hold Call]

See also:

- Rtriv - Retrieve Call on page 52.
-

HoldCW - Hold Call Waiting

Place the current call on hold and connects any call waiting. This function is not supported in the USA.

This function does not required any data to be entered when programmed. This function cannot be programmed through the phone by the user.

Pressing  **HoldCW** places the current call on hold and connects any call waiting without any ringing.

[User | Digital Telephony | Advanced | Hold | Hold CW]

IAuto - Automatic Intercom

Connects call to the extension without ringing.

This function requires entry of an extension number when programmed. The target extension must be support handsfree operation. This function cannot be programmed through the phone by the user.

Press  **IAuto** connects the call without any ringing at the remote extension. If the target extension is busy or not available, the call will follow any forwarding or diversion to voicemail set.

[User | Digital Telephony | Emulation | Automatic Intercom]

ICSeq - Set Inside Call Sequence

Sets the ringing pattern (sequence) used for internal calls.

This function is currently not supported on the 5620 telephone.

IDial - Dial Intercom

The same as IAuto - Automatic Intercom on page 45. This function cannot be programmed through the phone by the user.

[User | Digital Telephony | Emulation | Dial Intercom]

Inclu - Dial Inclusion

Intrudes on a call in progress at the target extension.

This function is currently not supported on the 5620 telephone.

Intru - Call Intrude

Intrudes on a call in progress at the target extension, creating a conference between the callers and the intruding extension.

This function requires entry of the target extension number when programmed. The  **Intru** key shows the target extension number. This function cannot be programmed through the phone by the user.

Pressing  **Intru** intrudes on the call in progress.

Note: That the System Administrator must configure the intruding extension as being able to intrude. Additionally none of the other extensions involved in the call can have "Cannot be intruded on" status.

[User | Digital Telephony | Advanced | Call | Call Intrude]

Listn - Call Listen

Allow the extension to listen to groups calls to the target extension. The call parties cannot hear the listening extension.

This function requires entry of the target extension number when programmed. This function cannot be programmed through the phone by the user.

The  **Listn** key shows the target extension number.

Use of this function requires setup of the extension's monitor group by the System Administrator. This function requires the telephone system to have some free conference capacity when invoked.

[User | Digital Telephony | Advanced | Call | Call Listen]

See also:

- Intru - Call Intrude on page 45.
- Recor - Call Record on page 53.
- Steal - Call Steal on page 53.

Login - Extn Login

Logs the current user onto the extension.

This function does not require any data to be entered when programmed. The user cannot program this function through the phone. Pressing the soft key login prompts the user **Enter Extn:**. The user enters the desired extension and presses the soft function key **Next**. The user is prompted for the password. The user enters the password and presses the soft function key "Done."

[User | Digital Telephony | Advanced | Extn | Extn Login]

Logof - Extn Logout

Logs the current user off the extension.

This function does not required any data to be entered when programmed. This function cannot be programmed through the phone by the user.

Pressing  **Logof** logs the current user off the extension. A new user must then log on to use the extension or dial ***36** to re-associate the extension with its default user.

[User | Digital Telephony | Advanced | Extn | Extn Logout]

Music - Hold Music

Plays the telephone system's music on hold.

This function does not required any data to be entered when programmed. This function cannot be programmed through the phone by the user.

Pressing  **Music** plays the telephone system's music on hold through the extension.

[User | Digital Telephony | Advanced | Hold | Hold Music]

NATim - Set No Answer Time

Sets the extension's no answer time after which ringing calls are forwarded or go to voicemail.

This function requires the time in seconds to be entered when programmed. The value is shown next to **NATim**. This function cannot be programmed through the phone by the user.

Pressing  **NATim** sets the extension's no answer time to the indicated number of seconds. This time is used to set a delay between ending one call and the next call ringing the extension (the waiting call may be indicated on the display however).

[User | Digital Telephony | Advanced | Set | Set No Answer Time]

See also:

- VMOff - Voicemail Off on page 55.

OCSeq - Set Outside Call Sequence

Sets the ringing pattern (sequence) used for internal calls.

This function is currently not supported on the 5620 telephone.

Page - Page

Page the specified target extension or group. The target must be capable of hands-free speech.

This function requires the target extension or group number to be specified when programmed. The target is then shown next to  **Page**. This function cannot be programmed through the phone by the user.



[User | Digital Telephony | Advanced | Dial | Dial Paging]

See also:



- GrpPg - Group Paging (!) on page 41.

Park - Park (#)

Park calls to and retrieve calls from a specific park slot.

This function requires entry of a park slot number when programmed. That number and **Park** then appears next to the  key. This function can be programmed through the phone by the user using an  **Admin 1** key.

The user can use the  key to park calls into that park slot and unpark calls from that slot. Parked calls can also be retrieved with the **Ride** function (see page 52).

When a call is parked in that park slot by the user, a  symbol appears next to the  key and parked by another user, then **Park** is underlined.

[User | Digital Telephony | Park]

See also:

- CPark - Call Park (!) on page 34.
- Park - Call Park to Other Extension (!) on page 48.
- Ride - Ride Call on page 52.

Park - Call Park to Other Extension (!)

Allows a call to be parked against another extension. Depending on the other extension's type, its parked call indication is triggered. Parked calls are retrieved with the **Ride** function (see page 52).

This function can be programmed with or without a target extension number. This function can be programmed through the phone by the user using an  **Admin** key.

If programmed with a number, the  **Park** key displays that number. After answering a call, pressing  **Park** parks the call against that extension.

If programmed without a number, after pressing  **Park** the target for the parked call must be entered.

The parked call is assigned a number based on the parking extensions number. For example, extension 290's first parked call is numbered 2900, it's next 2901 if 2900 is still parked and so on. If not retrieved elsewhere, a parked call will recall to the parking extension after a set time.



[User | Digital Telephony | Emulation | Call Park to Other Extension]

See also:

- CPark - Call Park (!) on page 34.
- Park - Call Park to Other Extension (!) on page 48.
- Ride - Ride Call on page 52.

PCall - Priority Call

Call a specified target extension even if that extension is set to 'Do not Disturb'.

This function can be programmed with or without an extension number being specified. If programmed with an extension number then the target extension is shown next to  **PCall**. If programmed without an extension number then the user has to enter the extension number when  **PCall** is pressed

This function cannot be programmed through the phone by the user.

[User | Digital Telephony | Advanced | Call | Priority Call]

PhyEx - Dial Physical Extension by Number

Dial a specified extension regardless of the current logged on user at that extension and any forwarding, follow me and do not disturb settings applied by the extension user.

This function requires the target extension number to be specified when programmed. The target extension is then shown next to  **PhyEx**. This function cannot be programmed through the phone by the user.

This function is currently only available on US based systems.

[User | Digital Telephony | Dial | Dial Physical Extension by Number]

PickA - Call Pickup Any

Pickup any ringing call.

This function does not require any data entered when programmed. This function cannot be programmed through the phone by the user.

Pressing  **PickA** answers any call currently ringing on the telephone system.

Note: We recommend that this function is only used on systems with a small number of users all in one area. Use of this function on larger system may lead to confusion.

[User | Digital Telephony | Advanced | Call | Call Pick Up Any]

See also:

- CPkUp - Call Pickup (!) on page 35.
- DPKUp - Directed Call Pickup (!) on page 37.

PickG - Call Pickup Group

Pickup any ringing call to a group of which the extension is a member.

This function does not require any data entered when programmed. This function cannot be programmed through the phone by the user.

Pressing  **PickG** answers any call currently ringing a group of which the extension is a member.

[User | Digital Telephony | Advanced | Call | Call Pick Up Group]

See also:

- CPkUp - Call Pickup (!) on page 35.
- DPKUp - Directed Call Pickup (!) on page 37.

PickM - Call Pickup Members

Pickup any call ringing an extension that is a member of the specified group.

This function requires entry of the target group number when programmed or the group name in quotation marks. This function cannot be programmed through the phone by the user.

Pressing  **PickM** answers any call currently ringing a member of the specified group. The call does not have to be a call to the group number.

[User | Digital Telephony | Advanced | Call | Call Pickup Members]

See also:

- CPkUp - Call Pickup (!) on page 35.
- DPKUp - Directed Call Pickup (!) on page 37.

Prog - Abbreviated Dial Program (!)

Select and program numbers against display keys.

This function can be programmed through the phone by the user using an  **Admin** key.

[User | Digital Telephony | Emulation | Abbreviated Dial Program]

See also:

- Dial (#) on page 30.
- AD - Abbreviated Dial (!) on page 32.

Quota - Clear Quota

Clears (resets) the time quota for connections to a specified external data service (eg. the internet).

This function requires entry of the service name when programmed. If left blank then the quotas for all services are cleared (reset). This function cannot be programmed through the phone by the user.

[User | Digital Telephony | Advanced | Call | Clear Quota]

Queue - Call Queue

Places a current call into the call queue of a specified extension. Allows calls to be transferred to extensions that return busy tone. This feature is not applicable when working with multiple Call Appearance lines.

This function requires entry of a target extension number when programmed. This function cannot be programmed through the phone by the user.

During a call, pressing  **Queue** places that call in the target extensions call queue. If the target extension is free, it rings immediately. If the target extension is busy, it rings when it becomes free again.

[User | Digital Telephony | Advanced | Call | Call Queue]



See also:

- DCW - Dial CW on page 36.

RBak+ - Ringback When Free

Sets a callback when free on busy extensions and callback when next used on unanswered extensions.

This function does not require any data entered when programmed. This function cannot be programmed through the phone by the user.

When an extension called does not answer or is busy, pressing  **AutCB** sets a callback on that extension. Whilst the callback is set, **AutCB** is shown with a  symbol. Pressing  **AutCB** again cancels the callback.

When the extension becomes free or is next used, **Ring Back to** and the number appears on the phone that set the callback. Pressing  answers the ringback and starts a call to the callback target.

[User | Digital Telephony | Advanced | Miscellaneous | Ringback When Free]





See also:

- AutCB - Automatic Callback (!) on page 32.

RBak - Cancel Ringback When Free

Cancels any set ringback when free function.

This function does not require any data entered when programmed. This function cannot be programmed through the phone by the user.

Pressing  **RBak-** switches off any set ring back when free. If the ringback was set using a  **AutCB** key, that key will still appear with a  symbol that can be cancelled by pressing the  **AutCB** key again.

[User | Digital Telephony | Advanced | Miscellaneous | Cancel Ringback When Free]

RBSeq - Set Ringback Sequence

Sets the ringing pattern (sequence) used for voicemail and ringback calls.

This function is currently not supported on the 5620 telephone.

Recor - Call Record

Records the current call at the specified target extension.

This function requires entry of a target extension number when programmed. This function cannot be programmed through the phone by the user.

When  **Recor** is pressed, the target extensions current call is recorded into their voicemail mailbox.

Note: This function requires Voicemail Pro to be installed. If advice of call recording is enabled, the call parties will hear a warning before the recording takes place. In some locations it may be a legal requirement to advise callers that a call is being recorded.

[User | Digital Telephony | Advanced | Call | Call Record]

See also:

- Listn - Call Listen on page 46.
 - Steal - Call Steal on page 53.
-

Relay - Relay Pulse

Pulse the specified external output relay (1 or 2) on for 5 seconds.

This function requires the relay switch (1 or 2) on the telephone system to be entered when programmed. This function cannot be programmed through the phone by the user.

Pressing  **Relay** switches the specified relay on for 5 seconds and then off.

[User | Digital Telephony | Advanced | Relay | Relay Pulse]

Rely+ - Relay On

Switch the specified external output relay (1 or 2) on.

This function requires the relay switch (1 or 2) on the telephone system to be entered when programmed. This function cannot be programmed through the phone by the user.

Pressing  **Relay** switches the specified relay on.

[User | Digital Telephony | Advanced | Relay | Relay On]

Rely- - Relay Off

Switch the specified external output relay (1 or 2) off.

This function requires the relay switch (1 or 2) on the telephone system to be entered when programmed. This function cannot be programmed through the phone by the user.

Pressing  **Relay** switches the specified relay off.

[User | Digital Telephony | Advanced | Relay | Relay Off]

Resum - Resume Call

Resume a call previously suspended into a specified ISDN exchange slot. This function is not supported in the USA.

This function requires the exchange slot number to be specified when programmed. The slot number is then shown next to  **Resum**. This function cannot be programmed through the phone by the user.

Pressing  **Resum** resumes any call previous suspended into the specified exchange slot. Suspended calls can be resumed by any extension.

[User | Digital Telephony | Advanced | Call | Resume Call]

See also:

- SusCW - Suspend CW on page 53.
- Suspe - Suspend Call on page 54.

Rtriv - Retrieve Call

Retrieve a call previously held into a specified ISDN central office slot and is only supported if the central office provides a Q.931 hold facility. This function is not supported in the USA.

This function requires the central office slot number to be specified when programmed. The slot number is then shown next to  **Rtriv**. This function cannot be programmed through the phone by the user.

Pressing  **Rtriv** retrieves any call previous held into the specified central office slot. Held calls can only be retrieved by the extension that put the call on central office hold.

[User | Digital Telephony | Advanced | Call | Retrieve Call]

See also:

- Hold - Hold Call on page 44.

Ride - Ride Call

Unpark a parked call from a specified system park slot.

This function requires the park slot number to be specified when programmed. The slot number is then shown next to  **Ride**. This function cannot be programmed through the phone by the user.

Pressing  **Ride** unparks any call previously parked into the specified system park slot by the same or another extension.

[User | Digital Telephony | Advanced | Call | Ride Call]



See also:

- CPark - Call Park (!) on page 34
- Park - Park (#) on page 47.
- Park - Call Park to Other Extension (!) on page 48.

RngOf - Ringer Off (!)

Switches the phones audible ringer on/off.

This function does not require any data entered when programmed. This function can be programmed through the phone by the user using an  **Admin** key.

The programmed  **RngOf** key toggles the phones call ringer on/off. When off, **RngOf** is shown with a  symbol.

[User | Digital Telephony | Emulation | Ringer Off]



See also:

- CWOn - Call Waiting On on page 35
- HfAns - Internal Auto-Answer (!) on page 42.

SAC - Send All Calls (!)

Switch do not disturb on/off.

This function does not require any data entered when programmed. This function can be programmed through the phone by the user using an  **Admin** key.

The  **SAC** key switches "do not disturb" on/off. When on, **SAC** is shown with a  symbol and the display includes an **N** (No calls).

When **SAC** is on, callers receive busy tone or are diverted to voicemail. For each user the System Administrator can set which numbers can still call when SAC is on. If the extension user has Phone Manager, they can set those numbers themselves. With a call already connected and another call already alerting, activating SAC will not affect the already alerting call.

[User | Digital Telephony | Emulation | Send All Calls]



See also:

- DNDOn - Do Not Disturb On on page 36.

Spres - AD Suppress (!)

Replace the display of dialed digits with **s** characters.



This function does not require any data entered when programmed. This function can be programmed through the phone by the user using an  **Admin** key.

The programmed  **Spres** key toggles the display of dialed digits on/off. When on, **Spres** is shown with a  symbol and each dialed digit is replaced by **s** on the display.

[User | Digital Telephony | Emulation | AD Suppress]

Steal - Call Steal

Take over a call from a specified extension or retrieve a call just transferred or forwarded. This function cannot be programmed through the phone by the user.

If a target extension number is entered when this function is programmed,  **Steal** displays that number. Pressing  **Steal** when the target extension has a call will take over the call.

If no target extension number is entered when the function is programmed,  **Steal** retrieves the last calls transferred from the extension. This includes calls diverted to voicemail.

- Notes:**
1. Target extension must not have *Cannot Intrude* set.
 2. Extension with **Steal** allocated must also have *Can Intrude* set.

[User | Digital Telephony | Advanced | Call | Call Steal]

SusCW - Suspend CW

Suspend the current call at the exchange and answer the waiting call.

If no exchange slot number is specified when the function is programmed, exchange slot 0 is used. This function cannot be programmed through the phone by the user.

Pressing  **SusCW** is only supported if the exchange provides a Q.931 suspend call facility.

[User | Digital Telephony | Advanced | Suspend | Suspend CW]

See also:

- Resum - Resume Call on page 52.

Suspe - Suspend Call

Suspend the current call at the exchange.

If no exchange slot number is specified when the function is programmed, exchange slot 0 is used. This function cannot be programmed through the phone by the user.

Pressing  **Suspe** is only supported if the exchange provides a Q.931 suspend call facility.

[User | Digital Telephony | Advanced | Suspend | Suspend Call]

See also:

- Resum - Resume Call on page 52.

Timer - Timer (!)

Starts a timer on the phone's display.

This function does not require any data entered when programmed. This function can be programmed through the phone by the user using an  **Admin** key.

The timer is reset for each new call made or answered. When timer mode is selected, a  is shown next to **Timer**.

[User | Digital Telephony | Emulation | Timer]

TmDay - Time of Day (!)

Replaces the user name and number details on the phone display with the date and time.

This function does not require any data entered when programmed. This function can be programmed through the phone by the user using an  **Admin** key.

When time and date mode is selected, a  is shown next to **TMDay**.

[User | Digital Telephony | Emulation | Time of Day]

Toggl - Toggle Calls

Cycle through each of the extension user's current held calls.

This function does not require any data entered when programmed. This function cannot be programmed through the phone by the user.

Pressing  **Toggl** puts the user's current call on hold and connects a previously held call.

[User | Digital Telephony | Advanced | Call | Toggle Calls]

VMRB- - Voicemail Ringback Off

Switches voicemail ringback for the extension off.

This function does not require any data entered when programmed. This function cannot be programmed through the phone by the user.



The  **VMRB-** key switches voicemail ringback for the extension off.

[User | Digital Telephony | Advanced | Voicemail | Voicemail Ringback Off]

VMRB+ - Voicemail Ringback On

Switches voicemail ringback for the extension on/off.

This function does not require any data entered when programmed. This function cannot be programmed through the phone by the user.

The  **VMRB+** key toggles voicemail ringback for the extension on/off. When on, **VMRB+** is shown with a  symbol and the extension is called when new messages are left in its mailbox.

[User | Digital Telephony | Advanced | Voicemail | Voicemail Ringback On]

VMCol - Voicemail Collect

Accesses a specified voicemail mailbox to collect or leave messages.

This function requires entry of the target mailbox name prefixed by either ? to collect messages or # to leave a message. If just ? or # is entered then the calling extension's mailbox is assumed. This function cannot be programmed through the phone by the user.

The  **VMCol** key appears followed by the mailbox name.

[User | Digital Telephony | Advanced | Voicemail | Voicemail Collect]

VMOff - Voicemail Off

Disables access to the user's voicemail box.

This function does not require any data entered when programmed. This function cannot be programmed through the phone by the user.



The  **VMOff** key switches voicemail operation for the extension off.

[User | Digital Telephony | Advanced | Voicemail | Voicemail Off]

VMOOn - Voicemail On

Enables/disables access to the user's voicemail box.

This function does not require any data entered when programmed. This function cannot be programmed through the phone by the user.

The  **VMOOn** key toggles voicemail operation for the extension on/off. When voicemail is on, **VMOOn** is shown with a  symbol.

[User | Digital Telephony | Advanced | Voicemail | Voicemail On]

WUTim - Set Wrap Up Time

Sets the extension's busy wrap up time to be inserted between calls.

This function requires the time in seconds to be entered when programmed. The value is shown next to **WUTim**. This function cannot be programmed through the phone by the user.

Pressing  **WUTim** sets the extension's busy wrap up time to the indicated number of seconds. This time is used to set a delay between ending one call and the next call ringing the extension (the waiting call may be indicated on the display however).

[User | Digital Telephony | Advanced | Set | Set Wrap Up Time]

See also:

- NATim - Set No Answer Time on page 47.

System Features

Introduction

As well as your phones specific features, you can access a number of system features by dialing short codes.

These instructions are for the system's default configuration. They assume that you are using the default feature codes. It also assumes that you have full access to all features and the public telephone network

Making Calls

Internal Calls: To make a call to another extension, simply dial the number.

If your System Administrator has allocated you the *Ring Back When Free* feature (see page 50) under a dial pad digit, you can:

1. When you call an extension that does not answer or is busy, press  **Feature** and then the relevant dial pad digit to set a callback on that extension.
2. When the extension you called becomes free, your phone will ring (a burst of three rings).
3. Lift the handset and the extension is called automatically.

External calls: To make an external call, either dial the number (prefixed by the access code if required) or use a *speed dial* code (contact your System Administrator for a list of your speed codes).

If you hear busy tone while dialing, then the call may be barred. Your system manager can bar certain calls, such as those to premium rate numbers and international calls

Answering Calls

Ringling at your own extension:

Simply pick up the handset. When in headset mode, press the button associated with the alerting call.

The default ringing cadences are:

- Internal calls have a single ring cadence
- External calls have a double ring cadence.

These can be changed by your System Administrator.

Ringling at another extension:

You can answer from your own phone by using *Call Pick-Up*; lift your handset and dial:

- ***30** to answer a call ringing anywhere.
- ***31** to answer a call within your group.
- ***32*201#** to answer the call for a particular extension, in this example 201.

Note: If your phone rings for any longer than a specified period (15 seconds in default), any re-direction feature that you have activated, such as voicemail or call forwarding, will come into effect.

Call Waiting

Call Waiting tells you if another call arrives while you are already making a call by providing call waiting tone. If you hear the call waiting tone, either end your current call or put the caller on hold. The waiting call should then ring.

- To turn call waiting on use the code ***15**; to turn it off use ***16**.

Call Forwarding

Your calls can be forwarded to another extension or an external number either when you are away from your desk (on no answer), when your extension is busy, and all calls (for example when you go on holiday).

- To switch forward direct station (i.e. not Hunt Group*) calls on dial ***01**, to switch it off dial ***02**.
- To switch forward on busy on dial ***03**, to switch it off dial ***04**.
- To switch forward on no answer on dial ***05**, to switch it off dial ***06**.
- To set the number to which your calls are forwarded dial ***07*201#**, forwarding to 201 in this example.

* To forward Hunt Group Calls On/Off, use ***50** and ***51** respectively.

Diverting Calls

You can divert your calls to another extension.

Note: If you do not answer calls at the temporary extension, they are forwarded to your own voicemail or call forwarding number.

At another extension:

- ***12*N#** from the extension you are temporarily using (where **N** is your extension number). Hence, calls to your extension will be diverted to the extension you are temporarily using.
- ***13*N#** to re-direct the calls back to your own extension, before you return to it.

At your own extension:

- ***14*N#** from your own extension (where **N** is the extension to which you want your calls diverted).
- ***14*#** to cancel either feature from your own extension.

Do Not Disturb

You may choose to receive no calls at all or only those from particular callers on your exceptions list:

To switch Do Not Disturb on/off (with or without exceptions):

- Dial ***08** and to switch it off dial ***09**.
- Dial ***10*N#** to add a number to the exception list.
- Dial ***11*N#** to delete a number from the exception list.

Note: Your callers, other than your exceptions, either hear busy tone or are re-directed to your voicemail.

Voicemail

Where your system has voicemail support and has been installed:

- To switch voicemail on dial ***18**, to switch it off dial ***19**.
- To retrieve your voicemail, use the code ***17**.

Your voicemail may be set up to deliver your messages by calling you whenever you hang up: this feature is known as Voicemail Ringback.

- To turn Voicemail Ringback on dial ***48**; to turn it off dial ***49**.

Dialing a number while listening to your messages invokes further facilities:

Once messages have been delivered, they are held on the system for 24 hours (can be modified by your System Administrator).

You can collect your voicemail from another extension by using the PIN your System Administrator has set up for you. You can collect your messages if you are out of the office, by either dialing from a number that has been registered for the purpose or by dialing your extension number and PIN when prompted. If validation is successful, then dial **1** to retrieve your mail.

The System Administrator also specifies the reception number, to which the call is diverted if the caller dials **0**, and your email address if your voicemail and email are integrated.

Default Feature Codes

The following are the normal default feature codes available to all users. Your System Administrator may add additional codes for other features and for speed dials.

The **N**, where shown, should be replaced by the appropriate number. For example, with ***07*N#**, replace **N** with the extension to which you want your calls forwarded when you have forwarding switched on.

*00	Cancel All Forwarding	*32*N#	Call Pick Up Extension
*01	Forward Unconditionally On	*33*N#	Call Queue
*02	Forward Unconditionally Off	*34	Hold Music
*03	Forward on Busy On	*35*N#	Extn Login
*04	Forward on Busy Off	*36*N#	Extn Logout
*05	Forward on No Answer On	*37*N#	Park Call
*06	Forward on No Answer Off	*38*N#	Ride Call
*07*N#	Forward to number	*39	Relay On
*08	Do Not Disturb On	*40	Relay Off
*09	Do Not Disturb Off	*41	Relay Pulse
*10*N#	Do Not Disturb Exception Add	*42	Relay On
*11*N#	Do Not Disturb Exception Delete	*43	Relay Off
*12*N#	Follow Me Here	*44	Relay Pulse
*13*N#	Follow Me Here Cancel	*45*N#	Call Steel
*14*N#	Follow Me To	*46	Call Steel
*15	Call Waiting On	*47	Conference Add
*16	Call Waiting Off	*48	Voicemail Ringback On
*17	Voicemail Collect	*49	Voicemail Ringback Off
*18	Voicemail On	*50	Forward Hunt Group Calls On
*19	Voicemail Off	*51	Forward Hunt Group Calls Off
*20*N#	Set Hunt Group Night Service	*52	Clear Call
*21*N#	Clear Hunt Group Night Service	*53*N#	Call Pickup Members
*29	Toggle Calls	*57*N#	Forward on busy number
*30	Call Pick Up Any	*70*N#	Dial Physical Extn by Number
*31	Call Pick Up Group	*71*N#	Dial Physical Extn by ID

Web Browsing

Overview of Web Browsing

The 5620 can act as a web browser for WAP (Wireless Application Protocol) web sites. These web sites contain pages written in a language called WML (Wireless Markup Language). The 5620 supports WML1.2.

If your telephone system has been setup with a default WAP website, the 5620 will display  **Web**. Pressing this key will display your systems default WAP website. The links and services on this site will control the WAP website and services you can access.





While browsing, you can still make and receive calls. But if you have **Phone Screen on Answer** option set to **Yes** and you answer an incoming call, the default phone screen will replace the existing web page in the display area.

To enter web browsing mode:

1. Press the  key under **Web**.

To exit web browsing mode:

1. Press  **Phone Exit**.
2. If  **Phone Exit** is pressed while browsing the web, the last web page viewed will be displayed when  **Web** is pressed again before a system reboot.

Accessing External WAP Websites

Your default WAP web site may contain a page where you can select or enter the URL of external WAP websites. If this is the case, you should be aware that some website may contain information that the 5620 is not able to display.











If the WAP web page uses WML features that the 5620 does not support, those features will not be shown.

If the WAP web page uses features that the 5620 does not recognize as valid WML 1.2, the 5620 will display **Not a valid WML page**.

Web Navigation Controls

Having pressed display  **Web** to access your default WAP website, the 5620 display shows a number of navigation controls.





- **Navigation Icon Buttons:**
These appear on the right-hand side of the web display. Note that they may appear grayed out when not useable.
 - **▲Up Page:**
Press the adjacent  key to move up the page by one screen (six lines).
 - **↑Up Line:**
Press the adjacent  key to move up the page by one line.
 - **🏠Home:**
Press the adjacent  key to return to the default WAP website's home page.
 - **🔄Refresh:**
Press the adjacent  key to reload the current page. If you had already selected another page to load this will cancel the loading of that page and reload the current page.
 - **↓Down Line:**
Press the adjacent  key to move down the page by one line.
 - **▼Down Page:**
Press the adjacent  key to move down the page by one screen (six lines).
- **Link Buttons:**
The  keys at the left hand edge of the screen are used to select links within the displayed web page. Links are indicated by underlined text. Only one link will appear on a line and pressing the adjacent  key will activate that link.
- **Page Buttons:**
The  keys across the base of the web display may be used to provide labeled links to other pages. If there are more than 3 such links, the right-hand  key will be labeled as **More**, press this key to display the additional options.
- **☎Phone Icon:**
If the ☎ icon appears next to a link in the web page, it indicates that the link is a telephone number. Pressing the adjacent  key to select the link will dial the number.

Entering Data

Some web pages may require you to enter data into a text field and then submit that data. For example, if you browse to a search engine web site like Google, you may be asked to enter a search field.



- **☐: Option (Radio Buttons)**

These allow you to select an option from a list by clicking on the adjacent left-hand  key. The selected option appears as .











- **[] : Text Entry Fields**

These normally appear as **[Enter text here]** or pre-filled with some data.

- **Submit Buttons**

Text entry and option key selections are not completed until submitted. Normally this will be done by a link, using a  or  key, labeled as **Submit** or similar. The exact appearance will vary between different web pages.

To enter text into a [] text entry field:

1. Press the left-hand  key adjacent to the [] text entry field.
2. The four  keys at the bottom of the screen change to:
 - **DONE:** Press this  key when your text entry is complete.
 - **BKSP:** Press this  key to delete the previous character.
 - **SPACE:** Press this  key to add a space.
 - **alpha:** This indicates the current text entry mode (in this example lower-case letters). Press the  key to select a different text entry mode.
3. Begin entering text using the telephone keypad. Each key is marked with the letters it provides. You may have to press the key more than once depending on the character you require.
 - For example, the **2** key is also marked as **A**, **B** and **C**. To enter a **C** press the key three times.
 - If the next character you want to enter is on the same key, press **1** and then enter the next character.
4. The right-most  key indicates the current text entry mode. To change the current mode, press the right-hand key. The available modes are shown along the bottom of the screen. They are:
 - **ALPHA:** Enter upper-case letters using the telephone keypad.
 - **alpha:** Enter lower-case letters using the telephone keypad.
 - **Num:** Enter numbers using the telephone keypad.
 - **Symbol:** Enter a symbol from the displayed menu. Possible symbols are: . , # @ * ' " ; : \ / - | \$ % ! ? & + = > < () ~ _ ^ [] { }. These are arranged in pages and you may have to press **MORE**  to select the required page. To enter a symbol, press the  key next to it.
5. When you have completed your text entry, press  **DONE** .
6. You can return to text entry by pressing the left-hand  key adjacent to the [] text entry field again.

Management and Troubleshooting

Overview

The 5620 IP Telephones are relatively trouble-free. This chapter provides helpful information for:

- Testing your telephone to be sure it is operating correctly.
- Basic Troubleshooting; this chart provides the most common problems an end user might encounter and suggested resolutions.
- Application-specific troubleshooting; this chart describes problems and solutions specific to a 5620 application (Phone, Speed Dial, Call Log, or Web Access).
- Resetting or power-cycling your phone, when Basic Troubleshooting does not resolve a problem.

Testing your phone



This test function enables you to verify that your telephone's lights and display are operating properly.

Testing the Telephone's Lights and Display

1. With the telephone idle (on-hook), press and release the  **Mute** button, then press the following numbers on the dial pad: 8 3 7 8 # (which stands for TEST).
 - The display should indicate the self-test has started. If the test is successful, the message "Self test Passed #=end" displays; if the test is not successful, the message "Self test Failed #=end" displays instead.
2. Press # to return to the Phone screen.
 - If nothing appears on the display and the phone is receiving power, your phone may need to be replaced. Contact your System Administrator for assistance or additional troubleshooting information.

Troubleshooting Chart

Problem/Symptom	Suggested Solution
Phone does not activate when connected for the first time.	Unless your System Administrator has already initialized your telephone, you may experience a delay of several minutes before it becomes operational. Upon plug-in, your telephone immediately begins downloading its operational software, its IP address, and any special features programmed by your System Administrator from the server to which it is connected. Report any delay of more than 10 minutes to your System Administrator.
Phone does not activate after a power interruption.	Allow a few minutes for re-initialization after unplugging, powering down the phone, server problems, or other power interruption causes.
Display shows an error/informational message	Most messages involve server/phone interaction. If you cannot resolve the problem based on the message received, contact your System Administrator for resolution.
Speakerphone does not operate.	Ask your System Administrator if your Speakerphone has been disabled.

Problem/Symptom	Suggested Solution
<p>Characters do not appear on the display screen.</p>	<p>See " Phone does not activate when connected for the first time" above.</p> <p>Check all lines into the phone to be sure it is properly connected.</p> <p>Check the power source to be sure your telephone is receiving power.</p> <p>Perform the following Test procedure: with the telephone idle (on-hook), press and release the  Mute button, then press the following numbers on the dial pad: 8 3 7 8 # (which stands for TEST). The display should indicate the self-test has started, then report if the test was successful or failed. If nothing appears on the display, and the phone is receiving power, your phone may need to be replaced.</p> <p>If the above suggested solutions do not resolve the problem, reset or power cycle the phone with your System Administrator's assistance.</p>
<p>No dial tone.</p>	<p>Make sure both the handset and line cords into the phone are securely connected. Note that there may be a slight operational delay if you unplug and reconnect the phone.</p> <p>Contact your System Administrator if the problem persists.</p>
<p>Phone does not ring</p>	<p>Set your ringer volume to a higher level using the  and  Up/Down Volume keys.</p> <p>From another phone, place a call to your extension to test the above suggested solution.</p>
<p>All other IP problems</p>	<p>Contact your System Administrator.</p>
<p>SPEED DIAL APPLICATION:</p> <p>You cannot dial out using any Speed Dial entries.</p> <p>You cannot add an entry to the Speed Dial list</p>	<p>Dial button. Check that all call appearances (incoming/outgoing lines) are not already in use. If all lines are in use, wait until a line is available to make your call.</p> <p>You have 108 Speed Dial entries, the maximum allowed. You must delete at least one entry before adding a new entry.</p>
<p>CALL LOG APPLICATION:</p> <p>You cannot dial out after selecting a call log entry.</p> <p>You cannot add an entry to the Speed Dial list.</p> <p>Dialing from this application does not go through.</p>	<p>Check that all call appearances (incoming/outgoing lines) are not already in use. If all lines are in use, wait until a line is available to make your call.</p> <p>You have 108 Speed Dial entries, the maximum allowed. You must delete at least one entry before adding a new entry.</p> <p>Your administrator must administer settings for the Enhanced Dialing feature beyond the defaults.</p>
<p>OPTIONS:</p> <p>No Options other than "View IP Settings" display</p>	<p>Your administrator has turned off all user-settable options.</p>

Resetting the IP Telephone

Reset your IP Telephone when other troubleshooting suggestions do not correct the problem or after being advised to do so by your System Administrator.

Resetting Your Phone

This basic reset procedure should resolve most problems.

1. Press the Mute button.
2. Using the dial pad, press the following keys in sequence: 73738#
 - The display shows the message “Reset values? * = no # = yes.”
3. Choose one of the following:
 - If you want to reset the phone without resetting any assigned values, press * (asterisk).
 - A confirmation tone sounds and the display prompts “Restart phone?”
 - * = no
 - # = yes.”
 - If you want to reset the phone and any previously assigned (programmed) values, press # (the pound key). (Use this option only if your phone has programmed, static values)
 - The display shows the message “Resetting values” while your IP Telephone resets its programmed values, such as the IP address, to its default values, and re-establishes the connection to the server. The display then prompts “Restart phone?”
 - * = no
 - # = yes.”

Note: Any reset/restart of your phone may take a few minutes.

Power Cycling Your Phone

Use the power cycle with your System Administrator’s approval only if the basic or programmed reset procedure cannot be performed or does not correct the problem:

1. Unplug the phone and plug it back in.
 - The phone connection is re-established.
2. If power-cycling does not correct the problem, your System Administrator can perform a more severe power cycle routine by unplugging both the phone and the Ethernet cables.

WARNING: Because the type of power cycle mentioned in Step 2 involves re-programming certain values, it should only be performed by your System Administrator.

EU24 Expansion Module

EU24 Overview

The EU24 Expansion Module is an optional device that can be connected to your 5620 IP Telephone to extend the number of call appearance and feature buttons available on the telephone.

The expansion module has 24 buttons arranged in two columns. Depending on how they have been programmed by your System Administrator, these buttons can be used for call appearances or features. You can adjust the viewing angle of the EU24 display to match that of your 5620 telephone.

The following figure shows a top view of the EU24 (the left hand column is displayed).



Key:

- 1. Call Appearance/Feature Button
- 2. Feature Active icon for feature in right column
- 3. Alternate Display Button
- 4. Feature Active icon for feature in left column
- 5. Display

Connection

Before you can begin using the EU24 Expansion Module, the module must be connected to the 5620 telephone according to the instructions in the *EU24 Expansion Module Installation and Safety Instructions* (555-233-136).

The following diagram shows an overview of these connections.



Using the EU24 Expansion Module

The following sections explain how to use the features of the EU24 Expansion Module. For more information, consult your System Administrator.

Viewing the Alternate Display

Although the EU24 Expansion Module supports an additional 24 call appearance/feature buttons, it only displays the button labels and icons for one column at a time. A dotted line separates the left column from the right column.

When you are viewing the labels and icons for the left column, the icons for the right column are displayed to the **right** of the dotted line. To view the column not currently displayed, press the Alternate Display button.

Selecting a Call Appearance/Feature Button

To select an available call appearance or feature, press the button next to the label in the column currently displayed.

If the call appearance or feature is not currently displayed, use the Alternate Display key to access the additional 12 call appearance/feature button labels.

Understanding Call Appearance/Feature Button Status Icons

When a call arrives for a call appearance on the EU24 Expansion Module, the bell icon blinks on the corresponding call appearance. To answer the call, press the button associated with the call appearance.

The icons displayed on the call appearance allow you to determine the status (for example, on hold) of each call on the EU24 Expansion Module. Icons also indicate whether a feature has been administered for a particular button on the EU24 Expansion Module. For an explanation of these icons see Call Appearance/Function Key Icons on page 9.

Index

Abbreviated Dial	32	Call Waiting	
Program	52	Clear	36
Absent Text	32	Dial.....	38
Absnt	32	Hold	47
Account Code Entry.....	32	Off.....	37
Acct.....	32	On.....	38
AD.....	32	Suspend.....	38 , 56
AD Suppress	56	Callback.....	34
Admin	32	Cancel	
Apear	34	All Forwarding.....	43
Appearance	34	Ringback When Free.....	53
Aquir	31	Cfrwd	36
AutCB	34	Characteristics.....	25
Auto-Answer	45	Clear	
Automatic		CW.....	36
Callback	34	Hunt Group Night Service.....	46
Intercom	47	Hunt Group Out of Service	47
Backup/restore		Clear Quota	52
modifying.....	25	ClrCW.....	36
Backup/restore	25	CnfRV.....	36
Backup/Restore Options.....	25	Conf+.....	36
Busy.....	34	Conference	
Forward Calls.....	42	Add	36
On Held.....	34	Rendezvous.....	36
BusyH	34	CPark	37
Call		CPkUp.....	37
Appearance.....	34	CWOff.....	37
Forwarding All.....	36	CWOn.....	38
Hold.....	47	CWSus	38
Intrude.....	48	DCW	38
Listen	48	Dial	30
Park.....	37 , 50	CW.....	38
Park to Other Extension.....	50	Direct	40
Pickup	37	Emergency.....	41
Priority.....	51	Inclusion.....	48
Queue	52	Intercom.....	48
Record	53	Physical Extension.....	51
Resume.....	54	Dial Tone	41
Retrieve.....	55	Dir 38	
Ride.....	55	Dirct.....	40
Steal.....	56	Directed Call Pickup.....	41
Suspend.....	57	Directory	38
Timer.....	57	Display Key	
Toggle	57	Dial.....	30
Call Pickup		Group.....	31
Any.....	51	User	31
Directed.....	41	DNDOF.....	40
Group.....	51	DNDOn.....	40
Members	52	DNDX-.....	40
		DNDX+	40

Index (Cont.)

Do Not Disturb		GrpPg	44
Exception Add	40	HdSet	45
Exception Delete	40	Headset Toggle	45
Off	40	Here-	45
On	40	Here+	45
DpkUp	41	HfAns	45
Drop	31	HGDis	46
DTone	41	HGE na	46
Emergency Dial	41	HGNS-	46
Emrgy	41	HGNS+	46
Extn		HGOS-	47
Login	49 , 53	HGOS+	47
Logout	49	Hold	47
Flash	41	Call Waiting	47
Follow Me		Hold Music	49
Here	45	HoldCW	47
Here Cancel	45	Hook Flash	41
To	42	Hunt Group	31
To Number	45	Disable	46
FolTo	42	Enable	46
Forward		Forward Calls	43
All	36	Night Service	46
Cancel All	43	Out of Service	47
Forward Number	43	Paging	44
Hunt Group Calls Off	43	Pickup	51
Hunt Group Calls On	43	IAuto	47
On Busy Number	42	ICSeq	48
On Busy Off	42	IDial	48
On Busy On	42	Inclu	48
On No Answer Off	44	Inclusion	48
On No Answer On	43	Inside Call Sequence	48
Unconditional Off	44	Intercom	47 , 48
Unconditional On	44	Internal Auto-Answer	45
FTP	25	Intru	31 , 48
FwBNo	42	Intrude	48
FwBOf	42	IP Telephone's	25
FwbOn	42	IP Telephone's backup/restore	25
FwdH	43	Listen	48
FwdH+	43	Listn	31 , 48
FwdOf	43	Login	49 , 53
FwNOf	44	Logof	49
FwNOn	43	Modifying	
FwUOf	44	Backup/Restore	25
FwUOn	44	Modifying	25
Group	31	Music	49
Disable	46	NATime	49
Enable	46	Night Service	46
Forward Calls	43	No Answer	
Night Service	46	Forward Calls	43
Out of Service	47	Time	49
Paging	44	Number	
Pickup	51	Follow Me To	42
		Forward Number	43
		Forward On Busy	42

Index (Cont.)

OCSeq	49	Secondary Dial Tone	41
On Busy		Self-Administer	32
Forward Calls	42	Send All Calls	56
On No Answer		Sequence	
Forward Calls	43	Outside Call	49
Option button	25	Ringback	53
Options/preference	25	Server IP Address	25
Out of Service	47	Set	
Outside Call Sequence	49	Absent Text	32
Paging	44	Hunt Group Night Service	46
Park	37 , 50	Hunt Group Out of Service	47
Park to Other Extension	50	Inside Call Sequence	48
Password	25	No Answer Time	49
PCall	51	Outside Call Sequence	49
Phone Button, Description	6	Ringback Sequence	53
PhyEx	51	Wrap Up Time	58
PickA	51	Speed Dials	25
PickG	51	Spres	56
PickM	52	Steal	56
Pickup		Suppress	56
Any	51	SusCW	56
Call	37	Suspe	57
Directed	41	Suspend	
Group	51	Call	57
Members	52	Call Waiting Suspend	38
Priority Call	51	CW	56
Prog	52	System Administrator	25
Queue	52	Time	
Quota	52	No Answer	49
RBak-	53	Wrap Up	58
RBak+	53	Time of Day	57
RBSeq	53	Timer	57
Recor	53	TmDay	57
Record Call	53	Toggl	57
Relay	54	Toggle Calls	57
Off	54	Toggle Headset	45
On	54	Transfer	25
Pulse	54	Transfer Protocol	25
Rely-	54	User	31
Rely+	54	User ID	25
Resum	54	VMCol	58
Resume Call	54	VMOff	58
Retrieve Call	55	VMon	58
Ride	55	VMRB-	57
Ringback		VMRB+	58
Cancel	53	Voicemail	
Sequence	53	Collect	58
When Free	53	Off	58
Ringback Off	57	On	58
Ringback On	58	Ringback Off	57
Ringer Off	55	Ringback On	58
RngOf	55	Wrap Up Time	58
Rtriv	55	WUTim	58
SAC	56		

Performance figures and data quoted in this document are typical, and must be specifically confirmed in writing by Avaya before they become applicable to any particular order or contract. The company reserves the right to make alterations or amendments to the detailed specifications at its discretion. The publication of information in this document does not imply freedom from patent or other protective rights of Avaya or others.

Intellectual property related to this product (including trademarks) and registered to Lucent Technologies have been transferred or licensed to Avaya.

All trademarks identified by the ® or ™ are registered trademarks or trademarks, respectively, of Avaya Inc. All other trademarks are the property of their respective owners.

This document contains proprietary information of Avaya and is not to be disclosed or used except in accordance with applicable agreements.

Any comments or suggestions regarding this document should be sent to "wgctechpubs@avaya.com".

© 2005 Avaya Inc. All rights reserved.

Avaya
Sterling Court
15 - 21 Mundells
Welwyn Garden City
Hertfordshire
AL7 1LZ
England

Tel: +44 (0) 1707 392200
Fax: +44 (0) 1707 376933

Email: contact@avaya.com
Web: <http://www.avaya.com>